

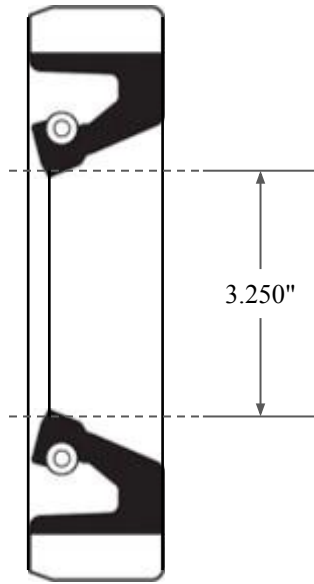

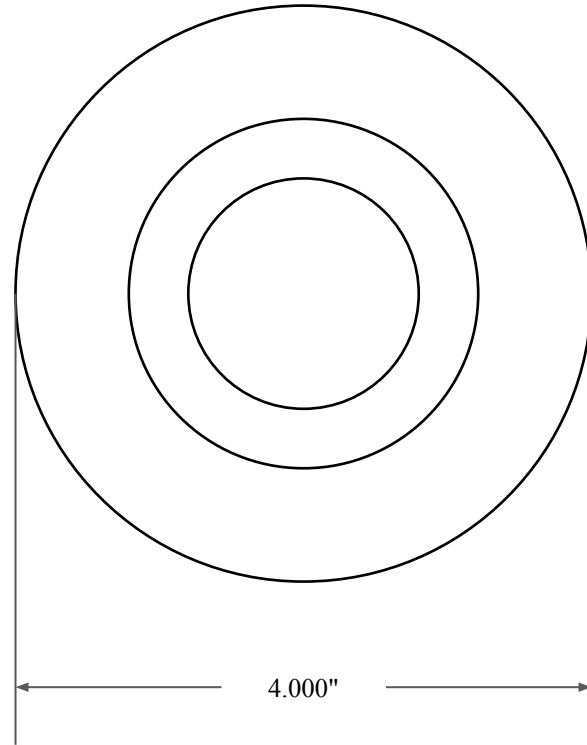

0.313"



3.250"



4.000"

 GLOBAL O-RING and SEAL ALL-AROUND BETTER	PART NUMBER FRS10381B
14450 John F. Kennedy Blvd. Houston, TX 77032	Fabric Reinforced Oil Seal - Nitrile 90 Style B Ref: JM Clipper 10973 H1L5
Information in this drawing is provided for reference only	