

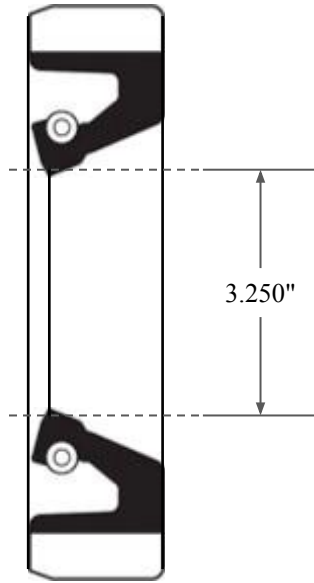

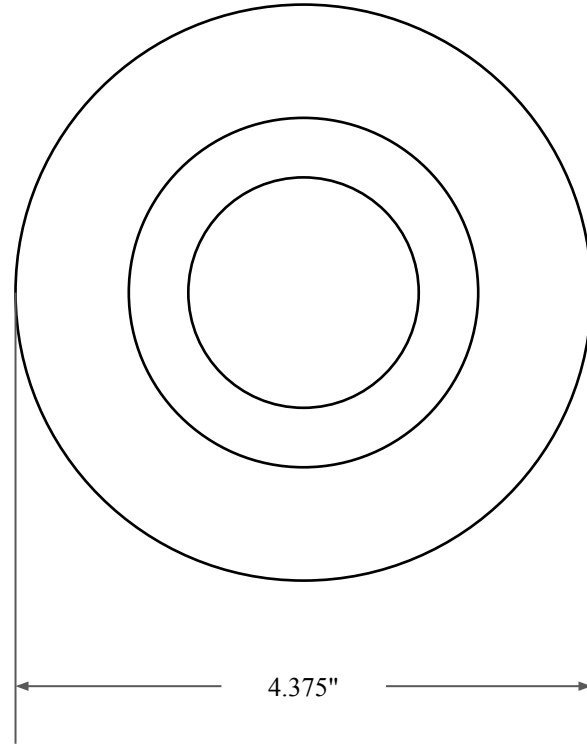

0.500"



3.250"



4.375"

 GLOBAL O-RING and SEAL ALL-AROUND BETTER	PART NUMBER FRS10411B
14450 John F. Kennedy Blvd. Houston, TX 77032	Fabric Reinforced Oil Seal - Nitrile 90 Style B Ref: JM Clipper 4054 H1L5
Information in this drawing is provided for reference only	