

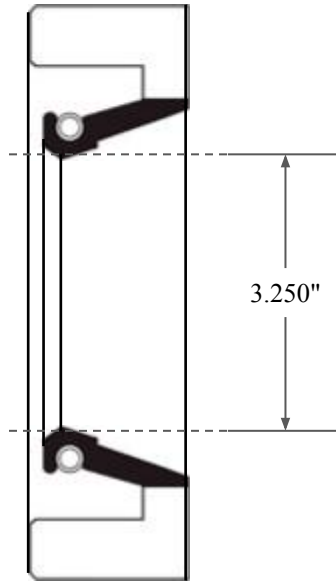

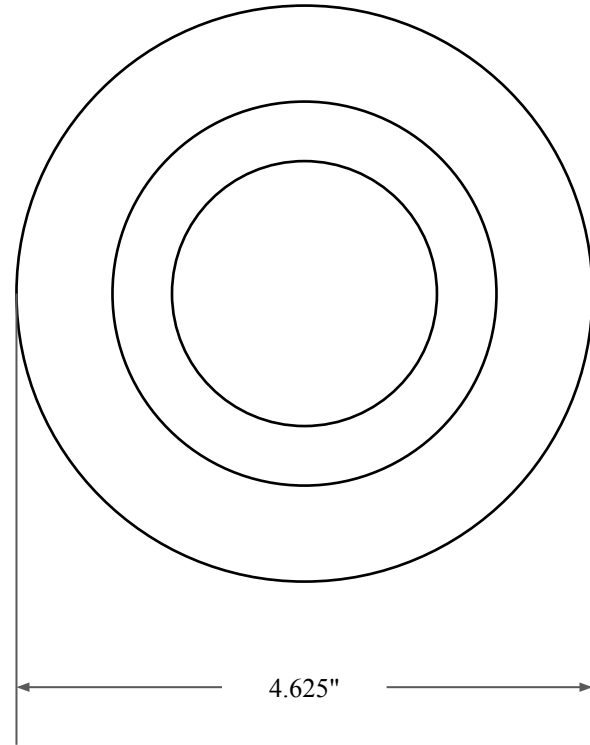

0.500"



3.250"



4.625"

 ALL-AROUND BETTER	PART NUMBER FRS10431A
14450 John F. Kennedy Blvd. Houston, TX 77032 www.globaloring.com	Fabric Reinforced Oil Seal - Nitrile 90 Style A Ref: JM Clipper 14748 H1L5
Information in this drawing is provided for reference only	