

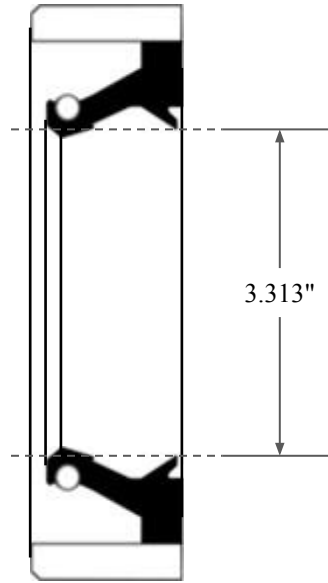

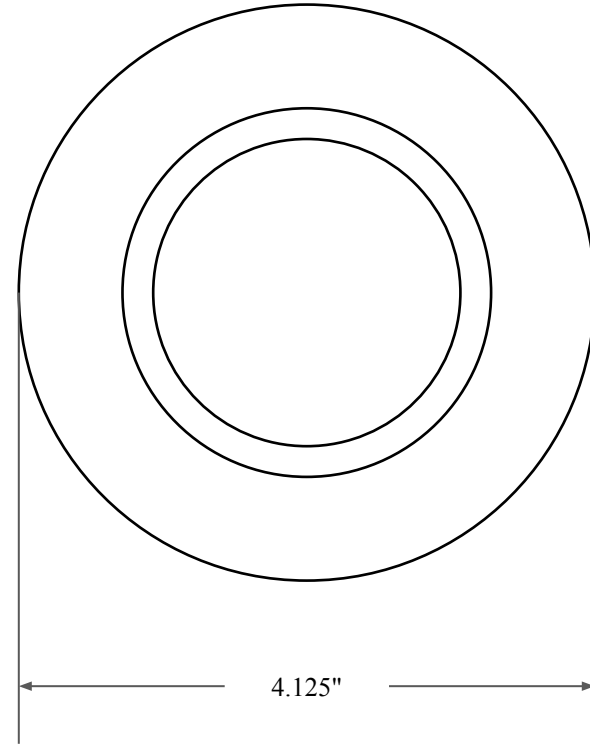

0.562"



3.313"



4.125"

 GLOBAL O-RING and SEAL ALL-AROUND BETTER	PART NUMBER FRS10495C
14450 John F. Kennedy Blvd. Houston, TX 77032	Fabric Reinforced Oil Seal - Nitrile 90 Style C Ref: JM Clipper 19488 H1L5
Information in this drawing is provided for reference only	