

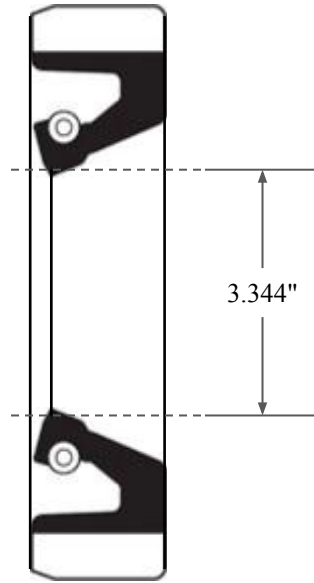

0.438"

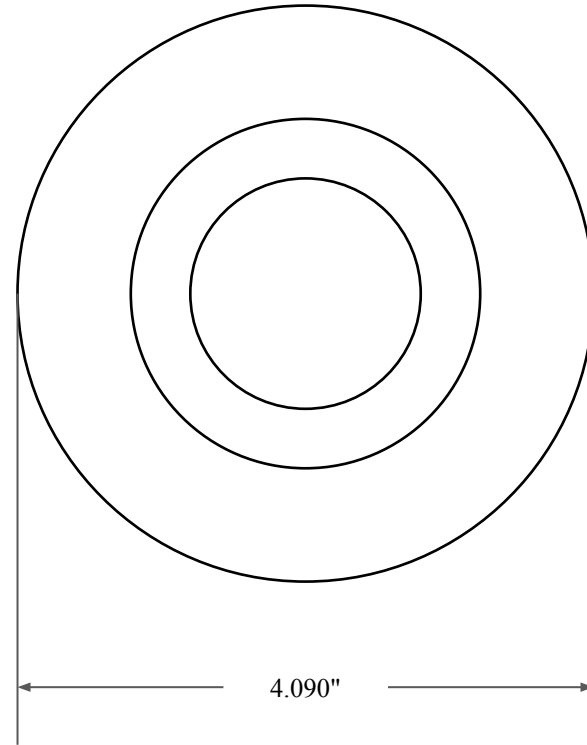

3.344"



4.090"



GLOBAL O-RING
and SEAL
ALL-AROUND BETTER

14450 John F. Kennedy Blvd.
Houston, TX 77032

www.globaloring.com

PART
NUMBER

FRS10516B

Fabric Reinforced Oil Seal - Nitrile 90 Style B
Ref: JM Clipper 0334 9728

Information in this drawing is provided for reference only