

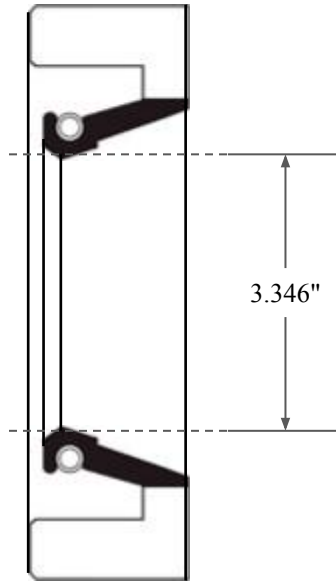

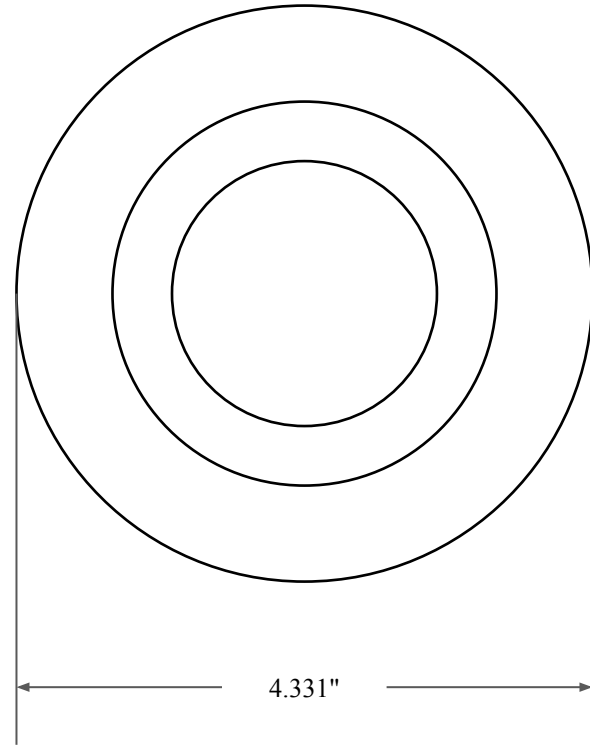

0.472"



3.346"



4.331"

|   |   |
|---|---|
|  <b>GLOBAL O-RING</b><br>and SEAL<br>ALL-AROUND BETTER | PART<br>NUMBER<br><b>FRS10545A</b>  |
| 14450 John F. Kennedy Blvd.<br>Houston, TX 77032<br><a href="http://www.globaloring.com">www.globaloring.com</a>                            | Fabric Reinforced Oil Seal - Nitrile 90 Style A<br>Ref: JM Clipper 15321 H1L5 |
| Information in this drawing is provided for reference only  |   |