

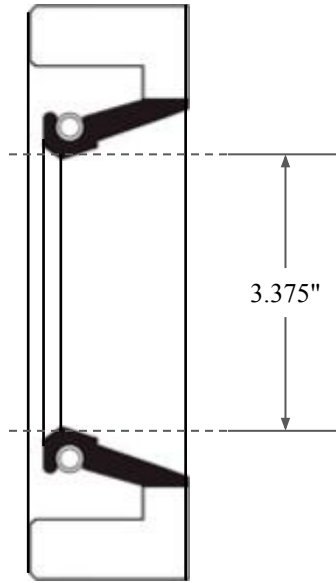

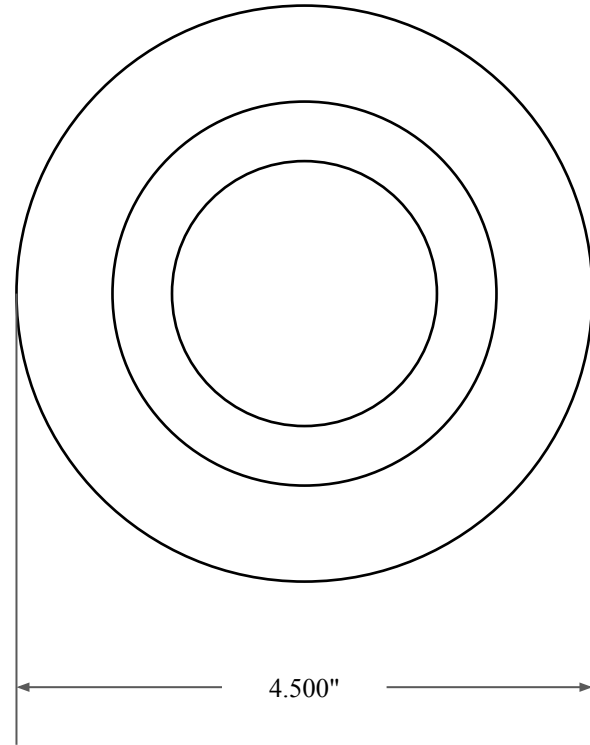

0.562"



3.375"



4.500"

 GLOBAL O-RING and SEAL ALL-AROUND BETTER	PART NUMBER FRS10619ANT
14450 John F. Kennedy Blvd. Houston, TX 77032 www.globaloring.com	Fabric Reinforced Oil Seal - Nitrile/PTFE 75 Style A Ref: JM Clipper 8841 HIL5 PTFE
Information in this drawing is provided for reference only	