

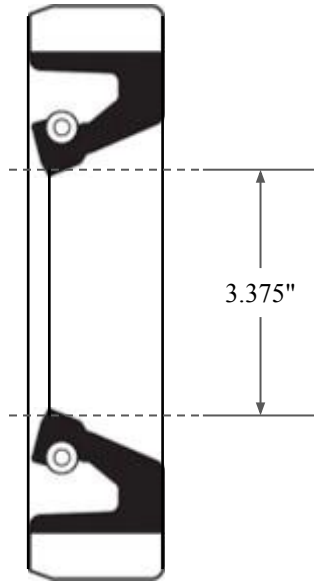

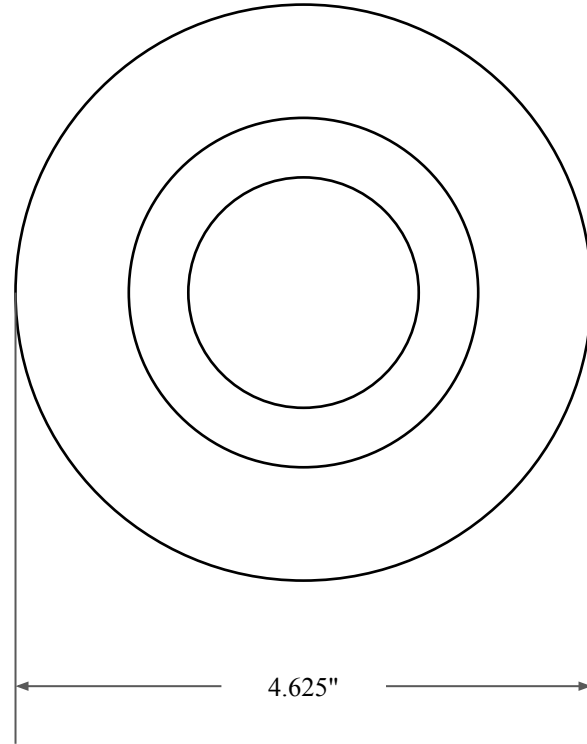

0.625"



3.375"



4.625"

 GLOBAL O-RING and SEAL ALL-AROUND BETTER	PART NUMBER FRS10626B
14450 John F. Kennedy Blvd. Houston, TX 77032	Fabric Reinforced Oil Seal - Nitrile 90 Style B Ref: JM Clipper 9272 H1L5
Information in this drawing is provided for reference only	