

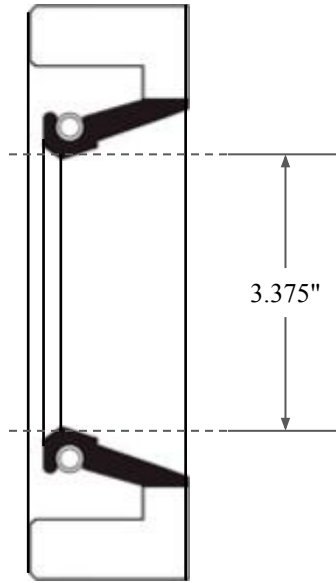

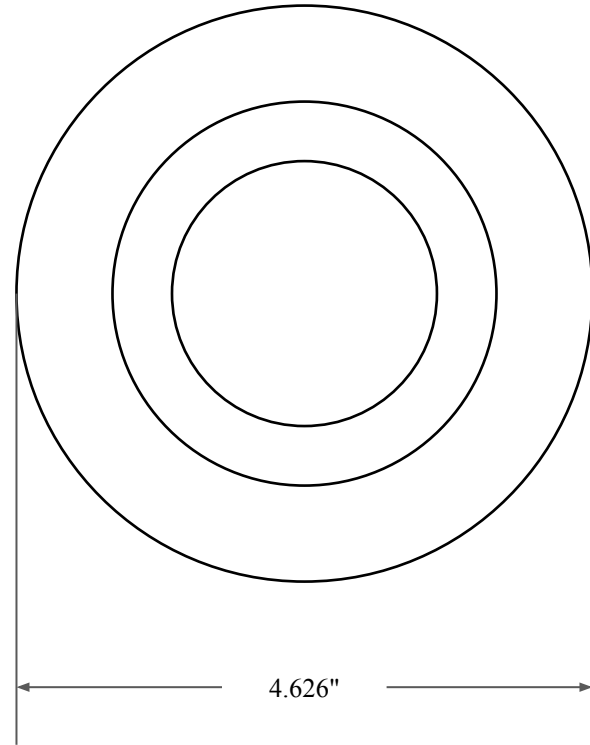

0.563"



3.375"



4.626"

 <b>GLOBAL O-RING</b> and SEAL ALL-AROUND BETTER	PART NUMBER <b>FRS10629AV90</b>
14450 John F. Kennedy Blvd. Houston, TX 77032 <a href="http://www.globaloring.com">www.globaloring.com</a>	Fabric Reinforced Oil Seal - Viton 90 Style A Ref: JM Clipper 11557 HSL16
Information in this drawing is provided for reference only	