

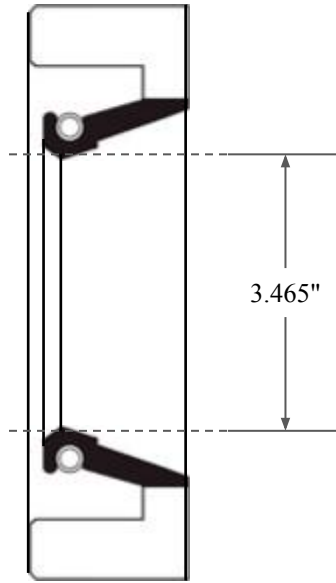

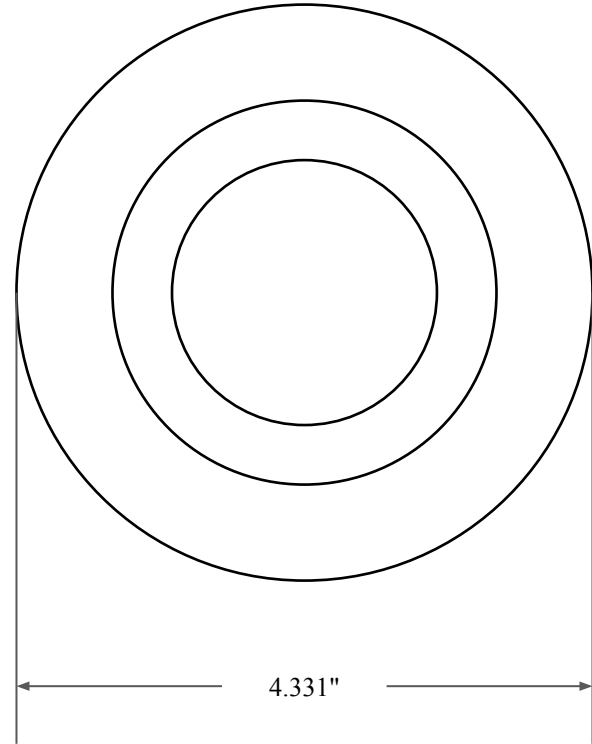

0.472"



3.465"



4.331"

 GLOBAL O-RING and SEAL ALL-AROUND BETTER	PART NUMBER FRS10715AV90
14450 John F. Kennedy Blvd. Houston, TX 77032 www.globaloring.com	Fabric Reinforced Oil Seal - Viton 90 Style A Ref: JM Clipper 17279 HSL16
Information in this drawing is provided for reference only	