

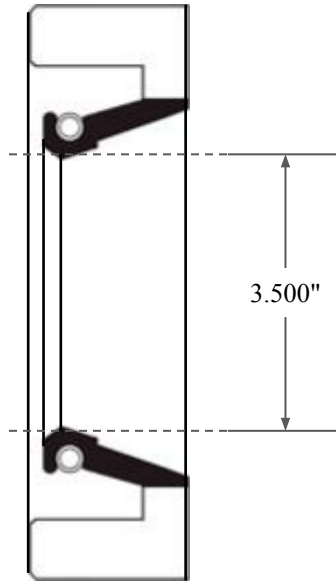

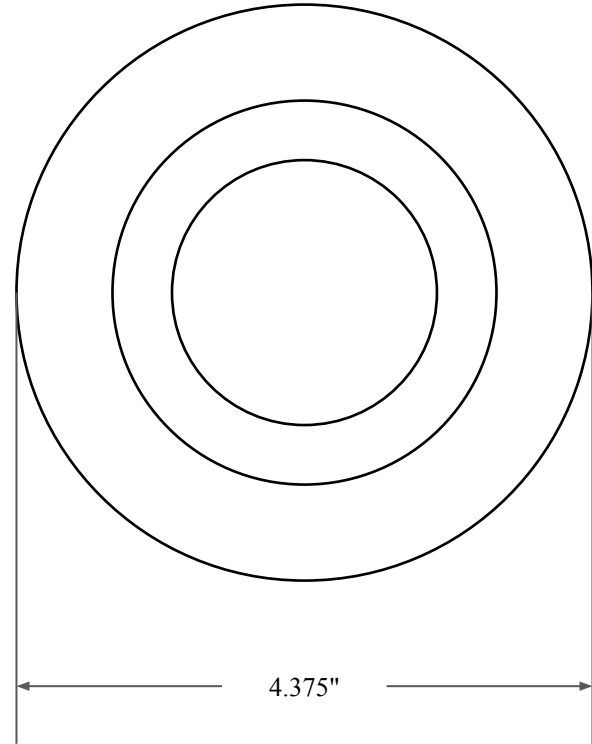

0.438"



3.500"



4.375"

 <p>GLOBAL O-RING and SEAL ALL-AROUND BETTER</p>	PART NUMBER <b>FRS10749A</b>
14450 John F. Kennedy Blvd. Houston, TX 77032	Fabric Reinforced Oil Seal - Nitrile 90 Style A Ref: JM Clipper 10773 H1L5
Information in this drawing is provided for reference only	