

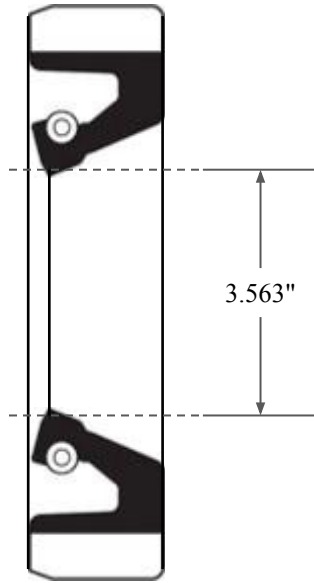

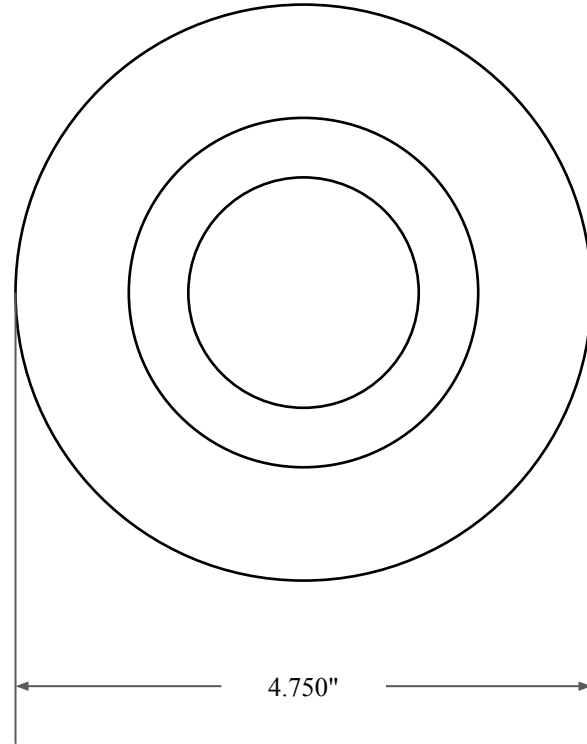

0.500"



3.563"



4.750"

 GLOBAL O-RING and SEAL ALL-AROUND BETTER	PART NUMBER FRS10915BV90
14450 John F. Kennedy Blvd. Houston, TX 77032 www.globaloring.com	Fabric Reinforced Oil Seal - Viton 90 Style B Ref: JM Clipper 10866 HSL16
Information in this drawing is provided for reference only	