

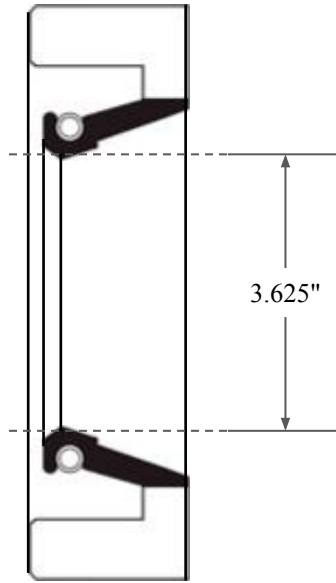

0.563"

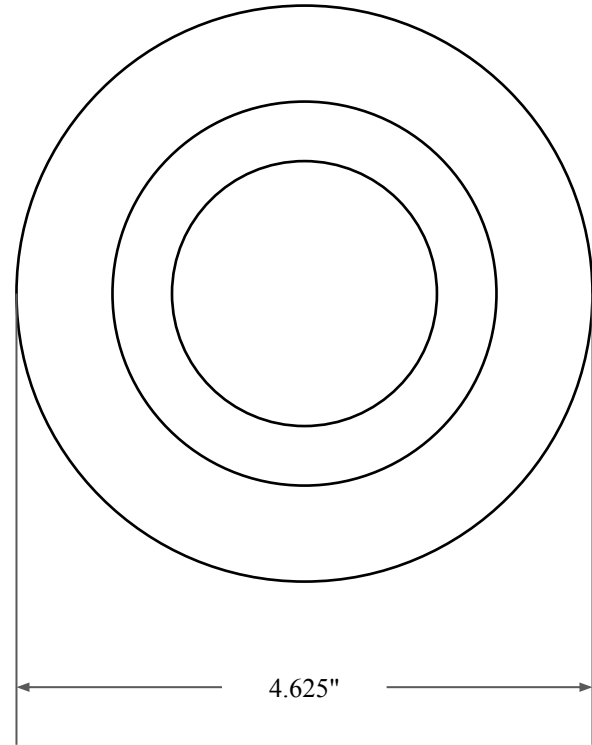

3.625"



4.625"



GLOBAL O-RING
and SEAL
ALL-AROUND BETTER

14450 John F. Kennedy Blvd.
Houston, TX 77032

www.globaloring.com

PART
NUMBER

FRS10956A

Fabric Reinforced Oil Seal - Nitrile 90 Style A
Ref: JM Clipper 12011 H1L5

Information in this drawing is provided for reference only