

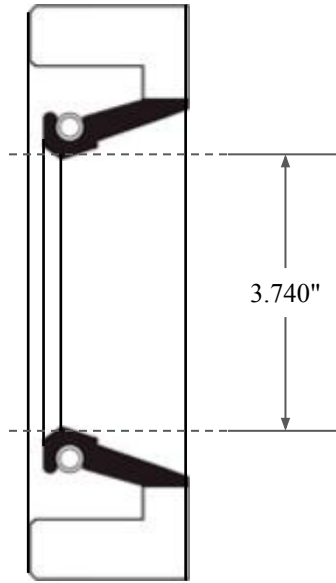

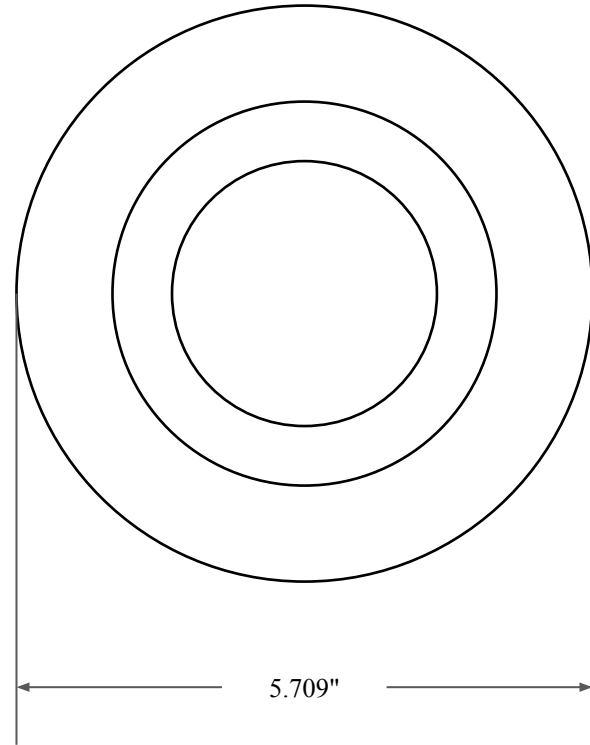

0.551"



3.740"



5.709"

 GLOBAL O-RING and SEAL ALL-AROUND BETTER	PART NUMBER FRS11094AV90
14450 John F. Kennedy Blvd. Houston, TX 77032 www.globaloring.com	Fabric Reinforced Oil Seal - Viton 90 Style A Ref: JM Clipper 18377 HSL89
Information in this drawing is provided for reference only	