

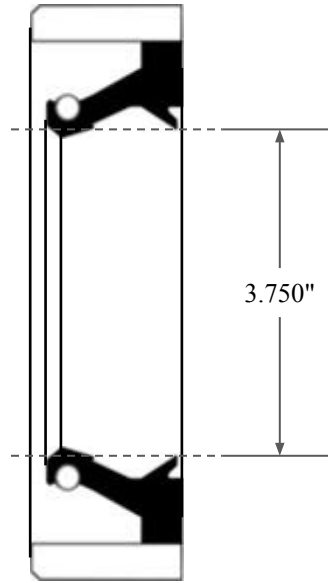

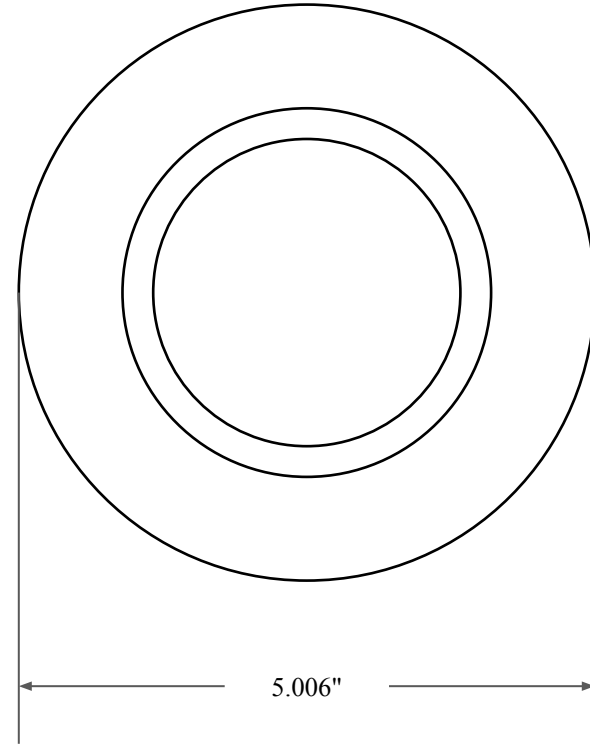

0.469"



3.750"



5.006"

 GLOBAL O-RING and SEAL ALL-AROUND BETTER	PART NUMBER FRS11140C
14450 John F. Kennedy Blvd. Houston, TX 77032	Fabric Reinforced Oil Seal - Nitrile 90 Style C Ref: JM Clipper 12797 H1L5
Information in this drawing is provided for reference only	