

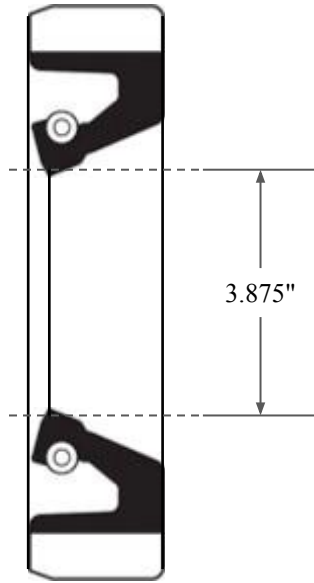

0.625"

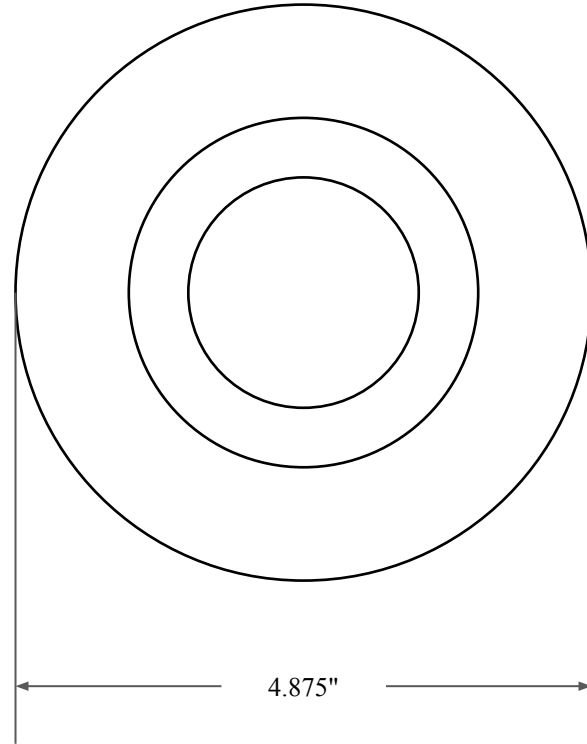

3.875"



4.875"

 GLOBAL O-RING and SEAL ALL-AROUND BETTER	PART NUMBER FRS11221BV90
14450 John F. Kennedy Blvd. Houston, TX 77032	Fabric Reinforced Oil Seal - Viton 90 Style B Ref: JM Clipper 10926 HSL16
Information in this drawing is provided for reference only	