

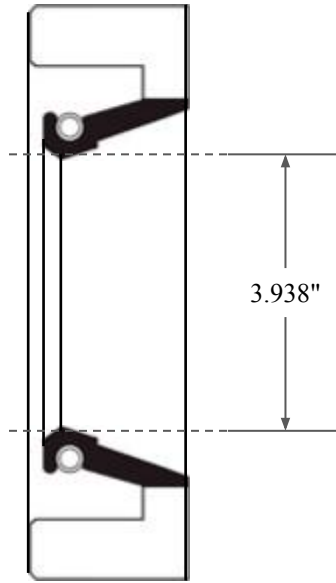

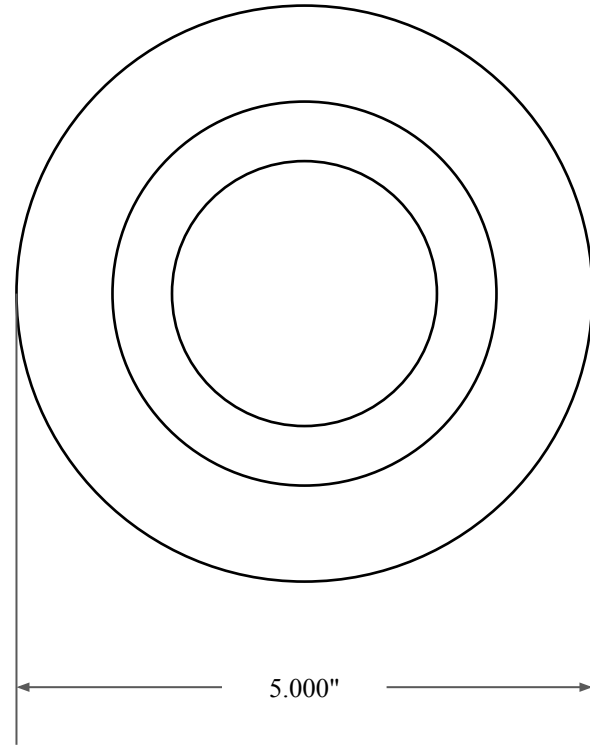

0.375"



3.938"



5.000"

 <b>GLOBAL O-RING</b> and SEAL ALL-AROUND BETTER	PART NUMBER <b>FRS11367ANT</b>
14450 John F. Kennedy Blvd. Houston, TX 77032 <a href="http://www.globaloring.com">www.globaloring.com</a>	Fabric Reinforced Oil Seal - Nitrile/PTFE 75 Style A Ref: JM Clipper 5910 HIL5 PTFE
Information in this drawing is provided for reference only	