

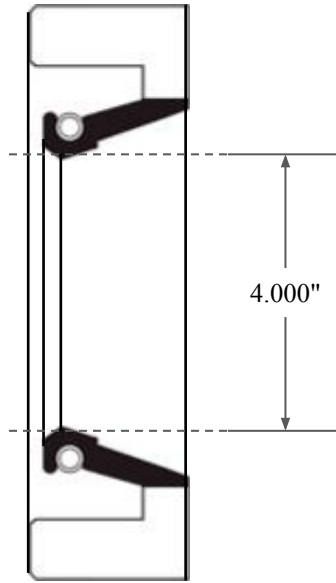

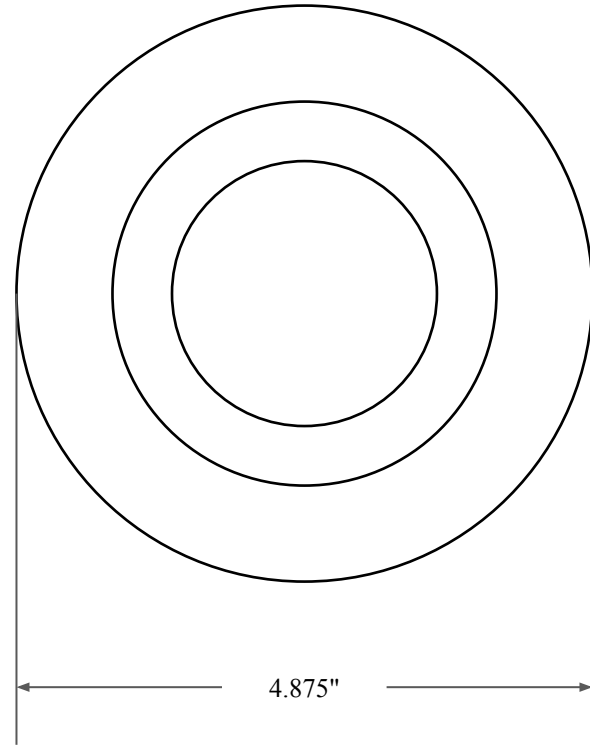

0.438"



4.000"



4.875"

 GLOBAL O-RING and SEAL ALL-AROUND BETTER	PART NUMBER FRS11408AV90
14450 John F. Kennedy Blvd. Houston, TX 77032	Fabric Reinforced Oil Seal - Viton 90 Style A Ref: JM Clipper 17309 H5L89
Information in this drawing is provided for reference only	