

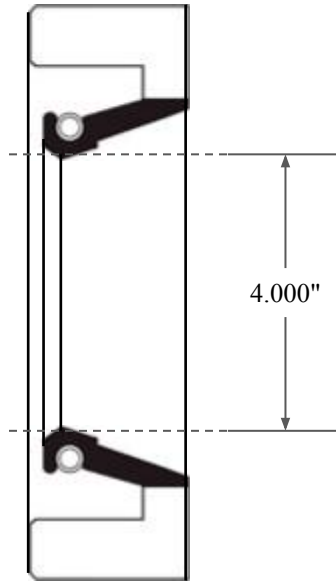

0.563"

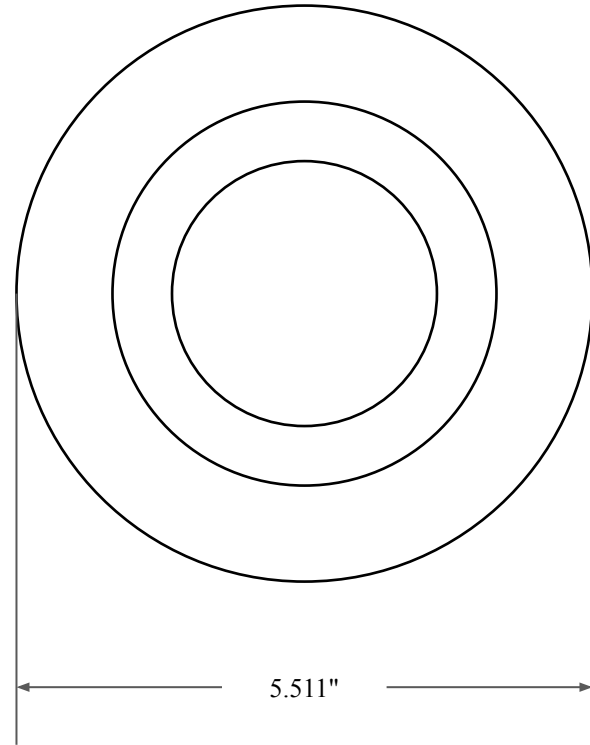

4.000"



5.511"



14450 John F. Kennedy Blvd.
Houston, TX 77032

www.globaloring.com

PART
NUMBER

FRS11465A

Fabric Reinforced Oil Seal - Nitrile 90 Style A
Ref: JM Clipper 13008 H1L5

Information in this drawing is provided for reference only