

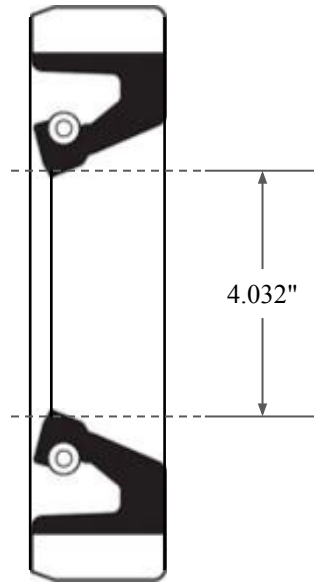

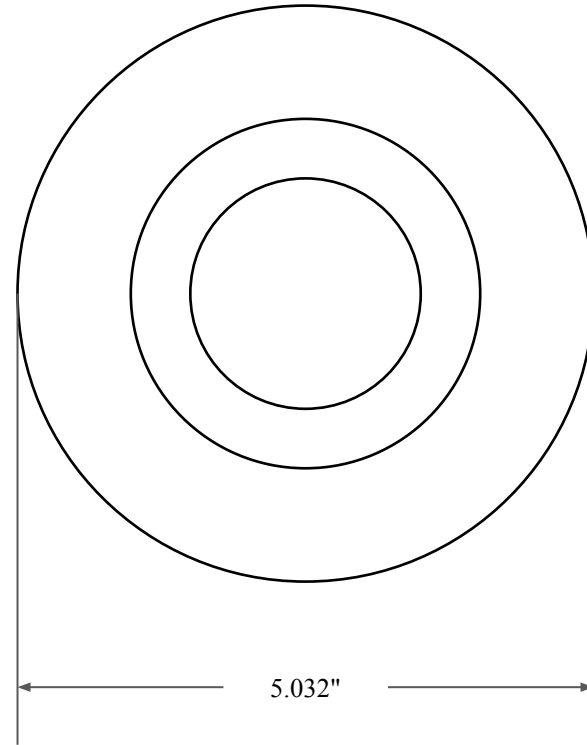

0.563"



4.032"



5.032"

 GLOBAL O-RING and SEAL ALL-AROUND BETTER	PART NUMBER FRS11497B
14450 John F. Kennedy Blvd. Houston, TX 77032 www.globaloring.com	Fabric Reinforced Oil Seal - Nitrile 90 Style B Ref: JM Clipper 0403 9473
Information in this drawing is provided for reference only	