

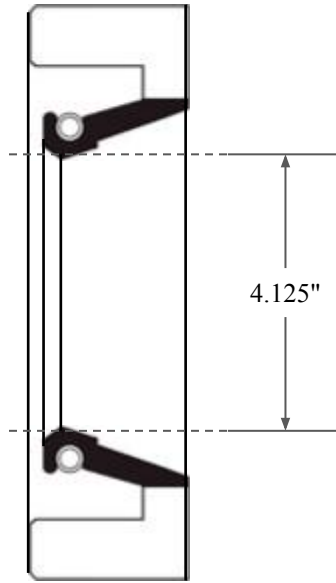

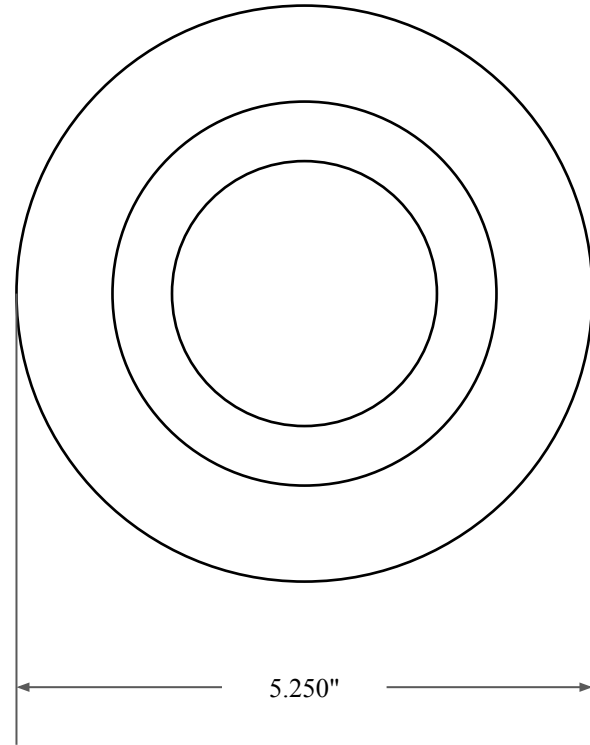

0.500"



4.125"



5.250"

 <b>GLOBAL O-RING</b> and SEAL ALL-AROUND BETTER	PART NUMBER <b>FRS11535AV90</b>
14450 John F. Kennedy Blvd. Houston, TX 77032 <a href="http://www.globaloring.com">www.globaloring.com</a>	Fabric Reinforced Oil Seal - Viton 90 Style A Ref: JM Clipper 11194 H5L16
Information in this drawing is provided for reference only	