

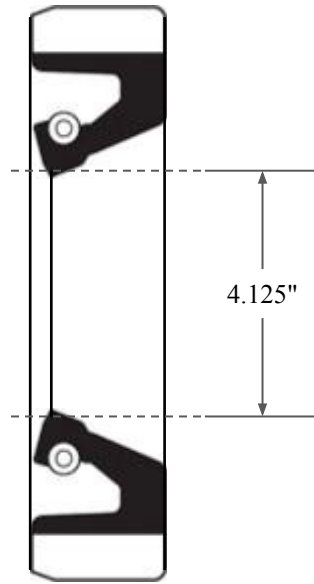

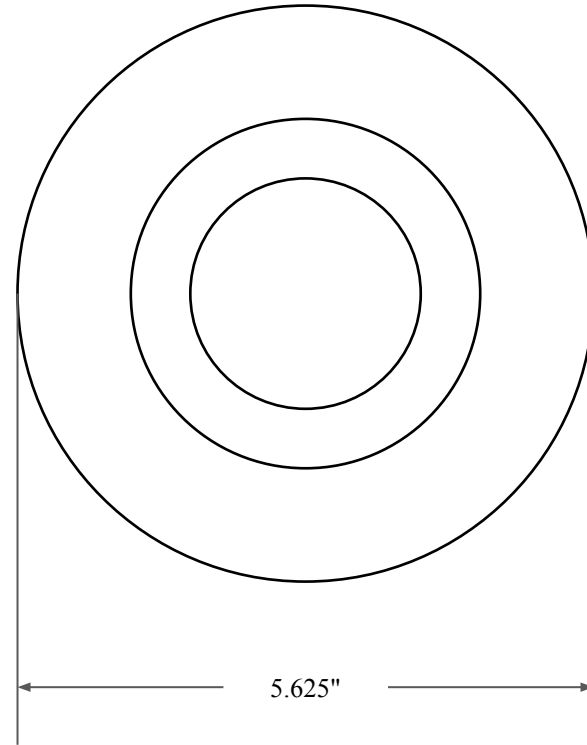

0.625"



4.125"



5.625"

 GLOBAL O-RING and SEAL ALL-AROUND BETTER	PART NUMBER FRS11549B
14450 John F. Kennedy Blvd. Houston, TX 77032	Fabric Reinforced Oil Seal - Nitrile 90 Style B Ref: JM Clipper 0412 15219
Information in this drawing is provided for reference only	