

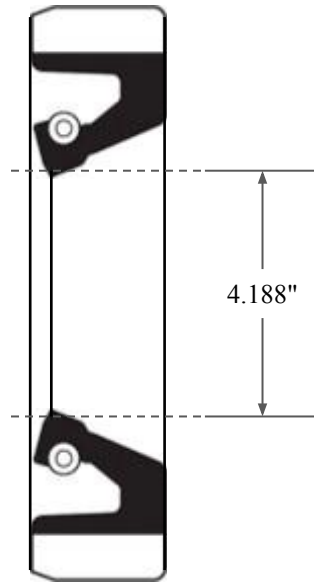

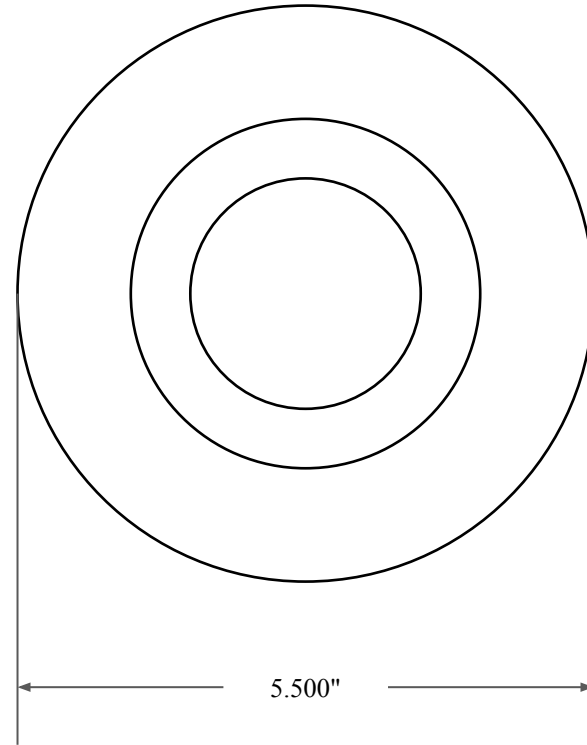

0.563"



4.188"



5.500"

 GLOBAL O-RING and SEAL ALL-AROUND BETTER	PART NUMBER FRS11627B
14450 John F. Kennedy Blvd. Houston, TX 77032	Fabric Reinforced Oil Seal - Nitrile 90 Style B Ref: JM Clipper 0418 10447
Information in this drawing is provided for reference only	