

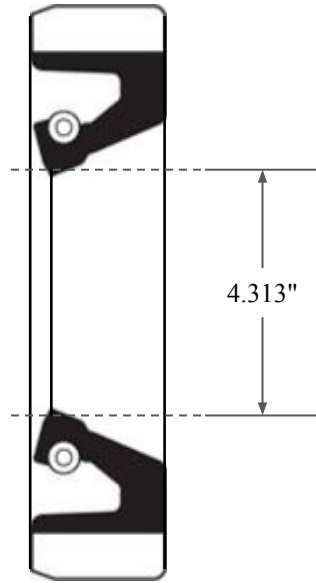

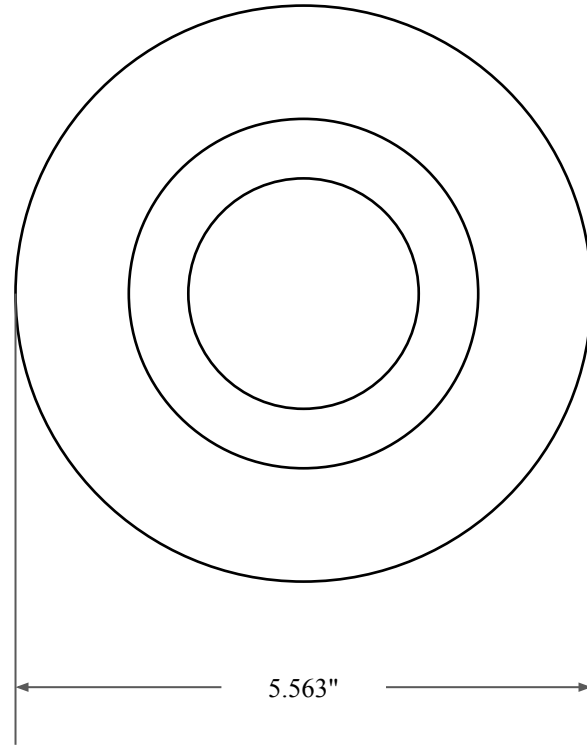

0.625"



4.313"



5.563"

 GLOBAL O-RING and SEAL ALL-AROUND BETTER	PART NUMBER FRS11730B
14450 John F. Kennedy Blvd. Houston, TX 77032	Fabric Reinforced Oil Seal - Nitrile 90 Style B Ref: JM Clipper 0431 9468
Information in this drawing is provided for reference only	