

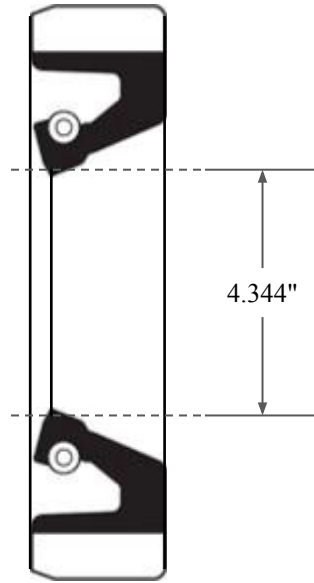

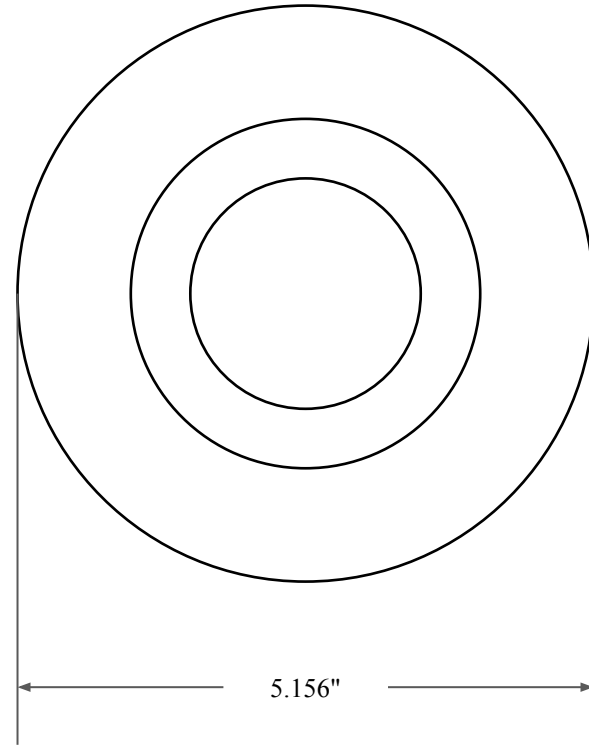

0.375"



4.344"



5.156"

 GLOBAL O-RING and SEAL ALL-AROUND BETTER	PART NUMBER FRS11804B
14450 John F. Kennedy Blvd. Houston, TX 77032	Fabric Reinforced Oil Seal - Nitrile 90 Style B Ref: JM Clipper 0434 8473
Information in this drawing is provided for reference only	