

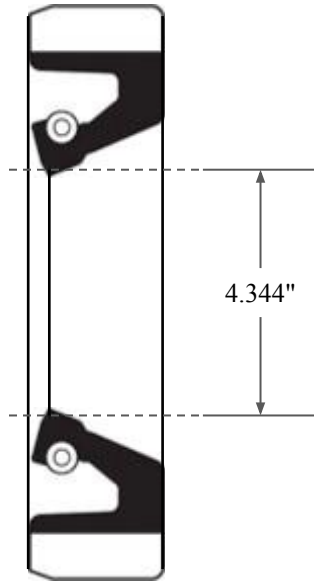

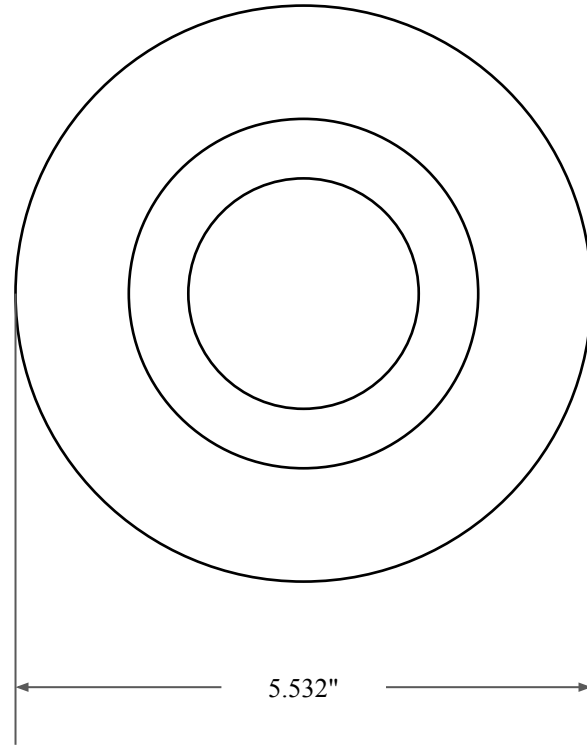

0.500"



4.344"



5.532"

 GLOBAL O-RING and SEAL ALL-AROUND BETTER	PART NUMBER FRS11808B
14450 John F. Kennedy Blvd. Houston, TX 77032	Fabric Reinforced Oil Seal - Nitrile 90 Style B Ref: JM Clipper 0434 10047
Information in this drawing is provided for reference only	