

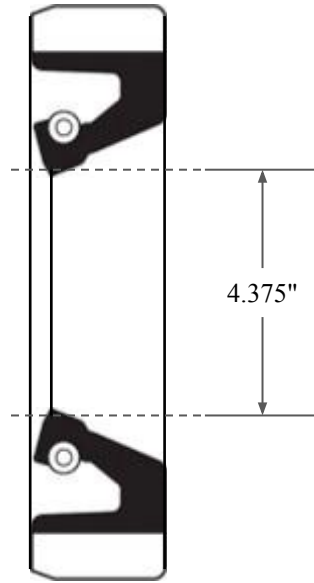

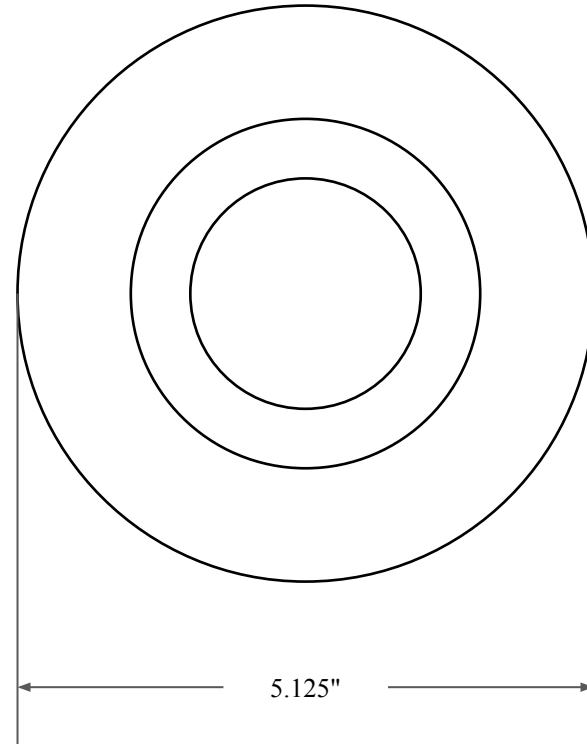

0.375"



4.375"



5.125"

 GLOBAL O-RING and SEAL ALL-AROUND BETTER	PART NUMBER FRS11813B
14450 John F. Kennedy Blvd. Houston, TX 77032	Fabric Reinforced Oil Seal - Nitrile 90 Style B Ref: JM Clipper 0437 14983
Information in this drawing is provided for reference only	