

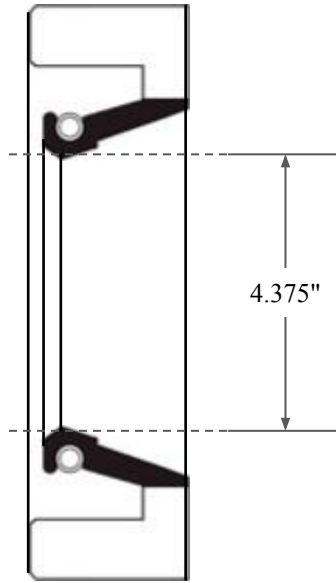

0.563"

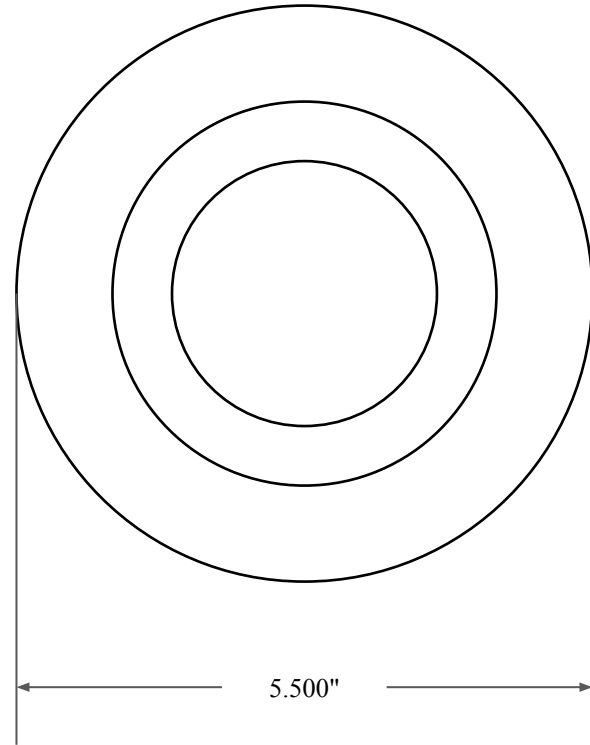

4.375"



5.500"



GLOBAL O-RING
and SEAL
ALL-AROUND BETTER

14450 John F. Kennedy Blvd.
Houston, TX 77032

www.globaloring.com

PART
NUMBER

FRS11823AV90

Fabric Reinforced Oil Seal - Viton 90 Style A
Ref: JM Clipper 8875 H5L16

Information in this drawing is provided for reference only