

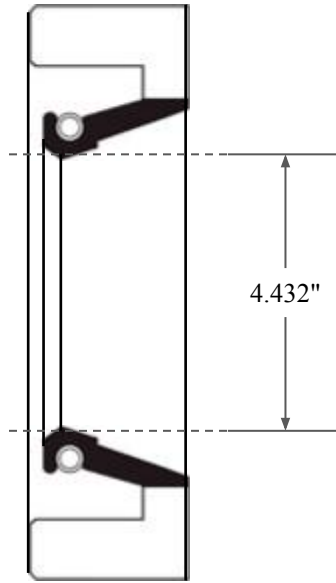

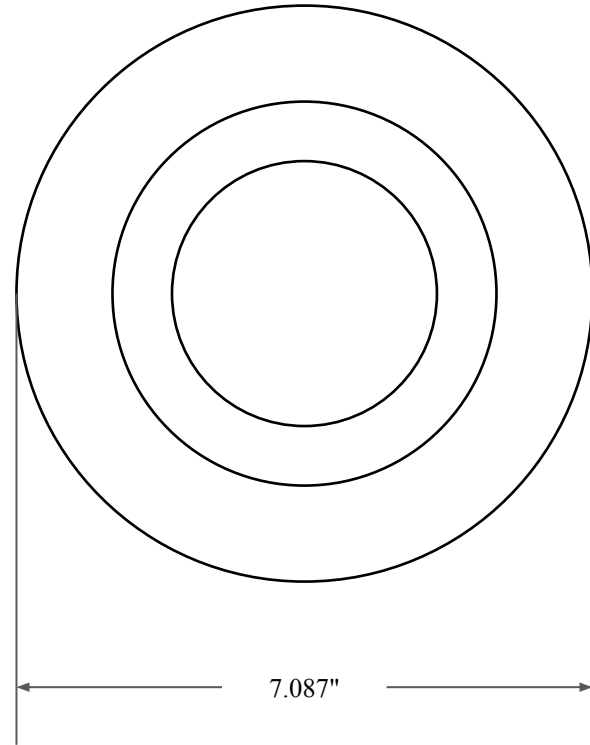

0.471"



4.432"



7.087"

 GLOBAL O-RING and SEAL ALL-AROUND BETTER	PART NUMBER FRS11861A
14450 John F. Kennedy Blvd. Houston, TX 77032 www.globaloring.com	Fabric Reinforced Oil Seal - Nitrile 90 Style A Ref: JM Clipper 10378 H1L5
Information in this drawing is provided for reference only	