

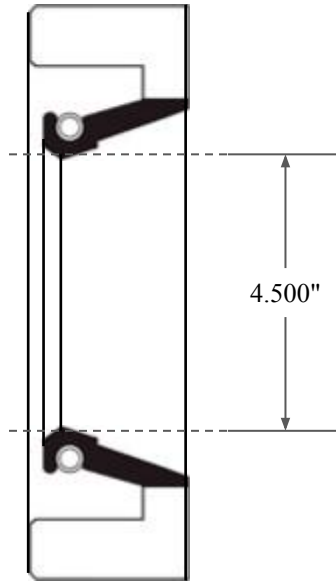

0.375"

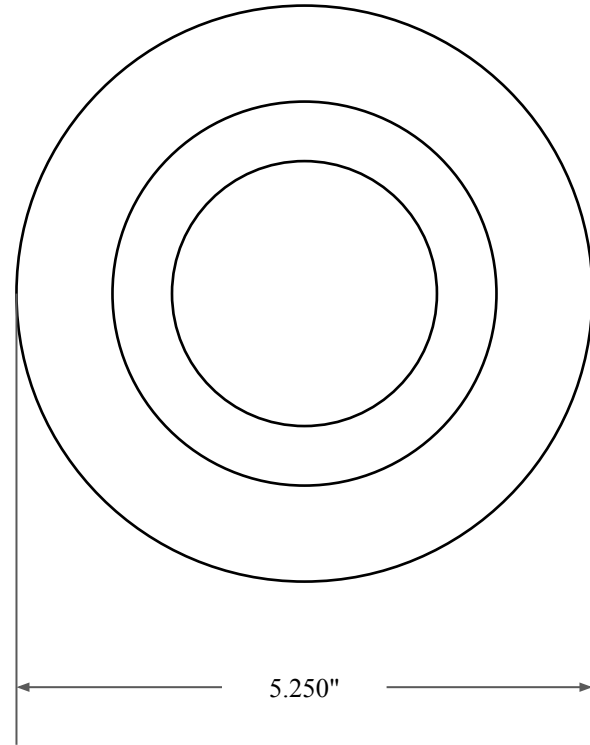

4.500"



5.250"



GLOBAL O-RING
and SEAL
ALL-AROUND BETTER

14450 John F. Kennedy Blvd.
Houston, TX 77032

www.globaloring.com

PART
NUMBER

FRS11907ANT

Fabric Reinforced Oil Seal - Nitrile/PTFE 75 Style A
Ref: JM Clipper 4168 HIL5 PTFE

Information in this drawing is provided for reference only