

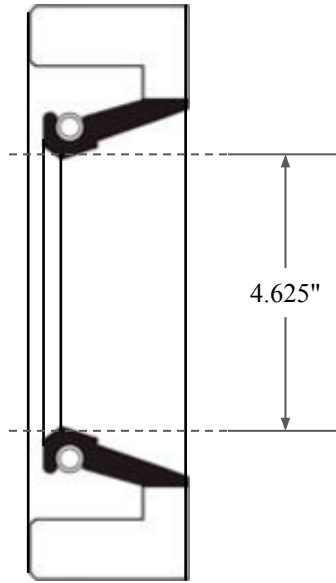

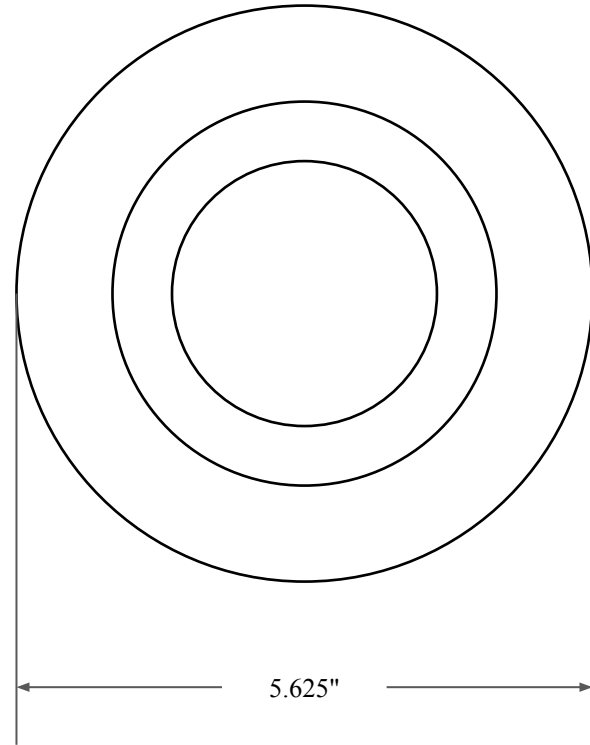

0.435"



4.625"



5.625"

 GLOBAL O-RING and SEAL ALL-AROUND BETTER	PART NUMBER FRS12039A
14450 John F. Kennedy Blvd. Houston, TX 77032 www.globaloring.com	Fabric Reinforced Oil Seal - Nitrile 90 Style A Ref: JM Clipper 3726 HIL5
Information in this drawing is provided for reference only	