

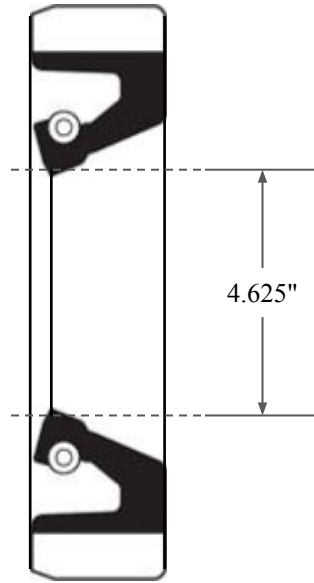

0.438"

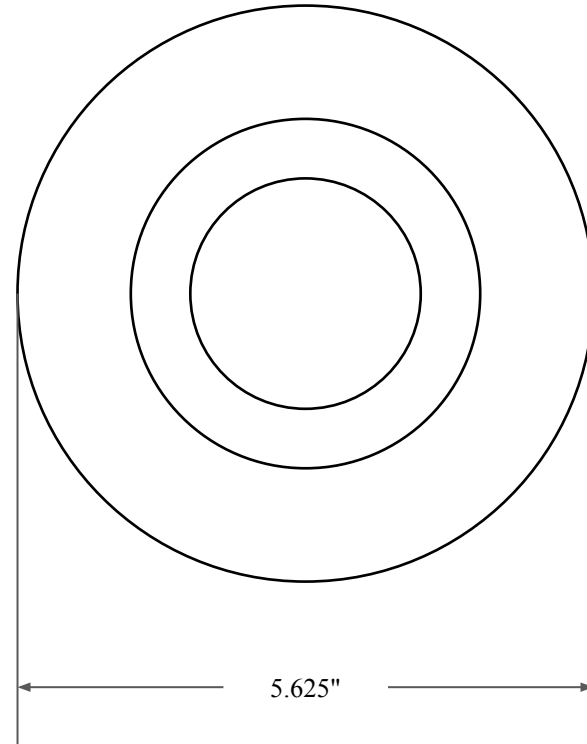

4.625"



5.625"



**GLOBAL O-RING**  
and SEAL  
ALL-AROUND BETTER

14450 John F. Kennedy Blvd.  
Houston, TX 77032

[www.globaloring.com](http://www.globaloring.com)

PART  
NUMBER

**FRS12040BV90**

Fabric Reinforced Oil Seal - Viton 90 Style B  
Ref: JM Clipper 5868 H5L16

Information in this drawing is provided for reference only