

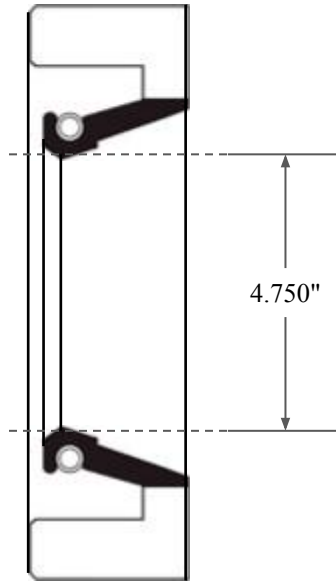

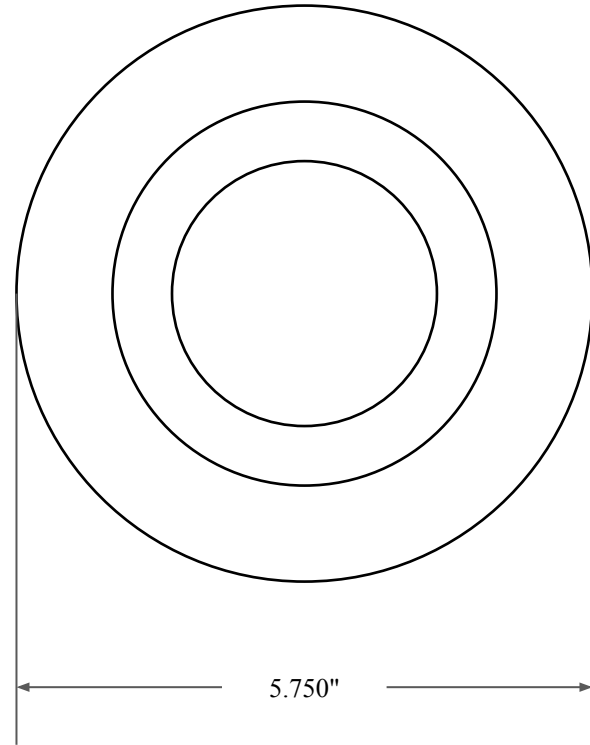

0.500"



4.750"



5.750"

 GLOBAL O-RING and SEAL ALL-AROUND BETTER	PART NUMBER FRS12167A
14450 John F. Kennedy Blvd. Houston, TX 77032	Fabric Reinforced Oil Seal - Nitrile 90 Style A Ref: JM Clipper 9820 H1L5
Information in this drawing is provided for reference only	