

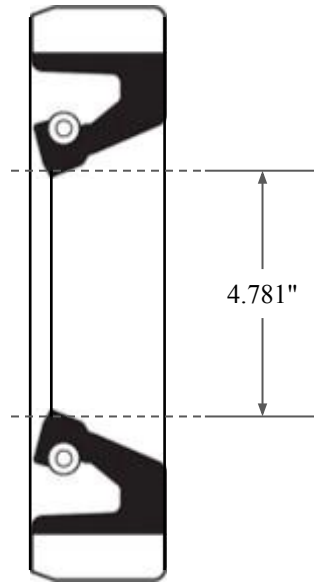

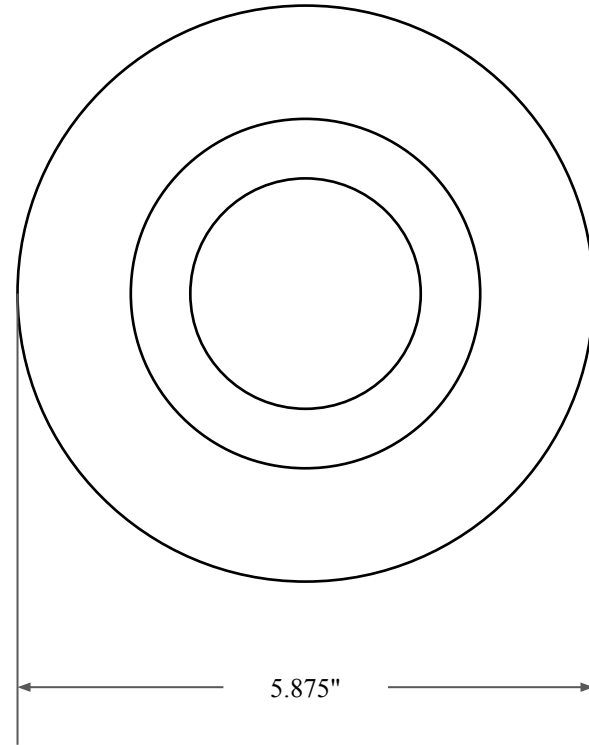

0.500"



4.781"



5.875"

 GLOBAL O-RING and SEAL ALL-AROUND BETTER	PART NUMBER FRS12200B
14450 John F. Kennedy Blvd. Houston, TX 77032	Fabric Reinforced Oil Seal - Nitrile 90 Style B Ref: JM Clipper 0478 9737
Information in this drawing is provided for reference only	