

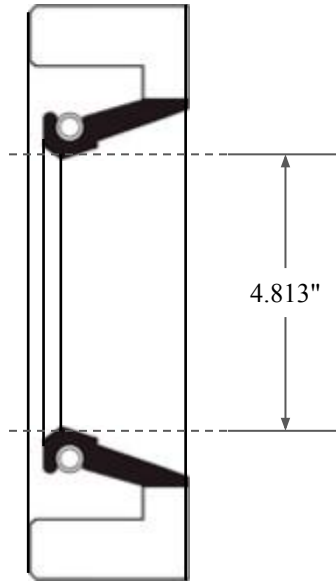

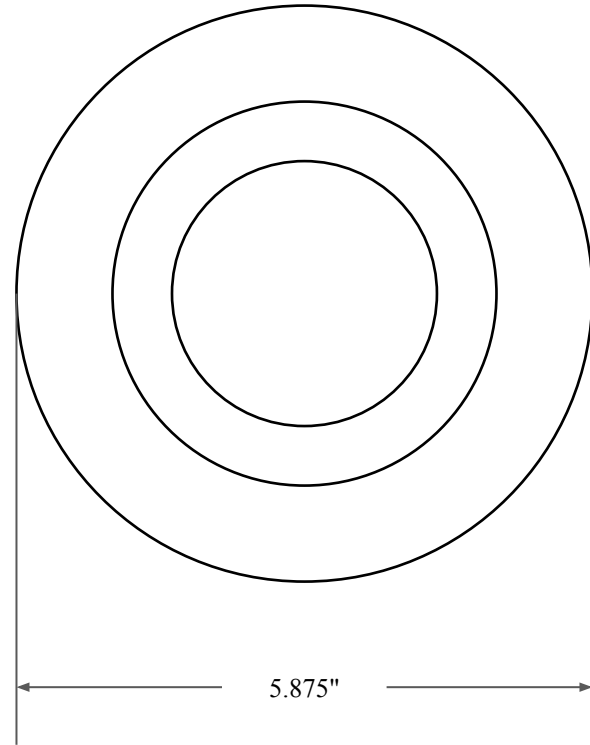

0.500"



4.813"



5.875"

 <p>GLOBAL O-RING and SEAL ALL-AROUND BETTER</p>	PART NUMBER FRS12220A
14450 John F. Kennedy Blvd. Houston, TX 77032	Fabric Reinforced Oil Seal - Nitrile 90 Style A Ref: JM Clipper 12903 H1L5
Information in this drawing is provided for reference only	