

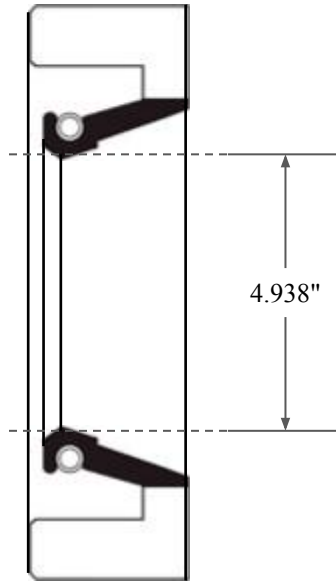

0.563"

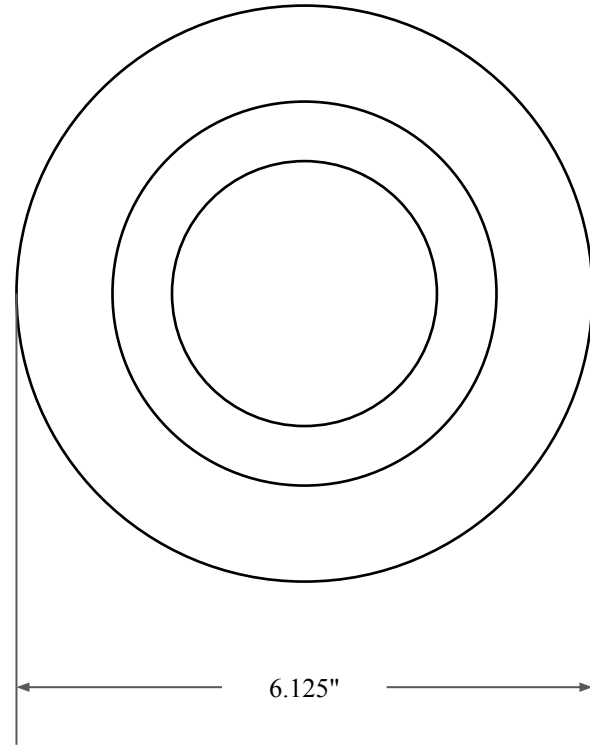

4.938"



6.125"



GLOBAL O-RING
and SEAL
ALL-AROUND BETTER

14450 John F. Kennedy Blvd.
Houston, TX 77032

www.globaloring.com

PART
NUMBER

FRS12317A

Fabric Reinforced Oil Seal - Nitrile 90 Style A
Ref: JM Clipper 11990 H1L5

Information in this drawing is provided for reference only