

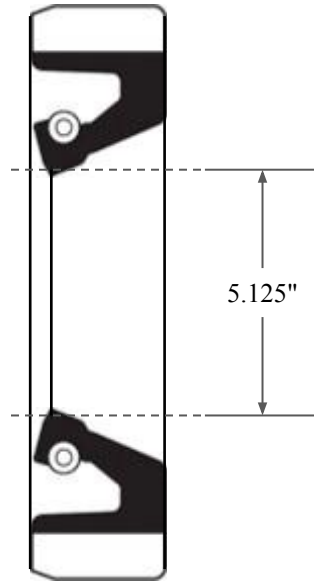

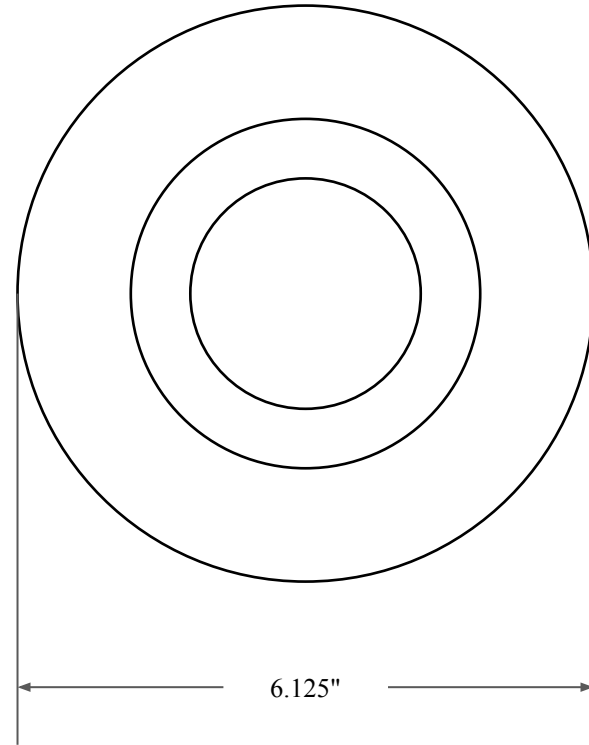

0.438"



5.125"



6.125"

 GLOBAL O-RING and SEAL ALL-AROUND BETTER	PART NUMBER FRS12445B
14450 John F. Kennedy Blvd. Houston, TX 77032	Fabric Reinforced Oil Seal - Nitrile 90 Style B Ref: JM Clipper 0512 3727
Information in this drawing is provided for reference only	