

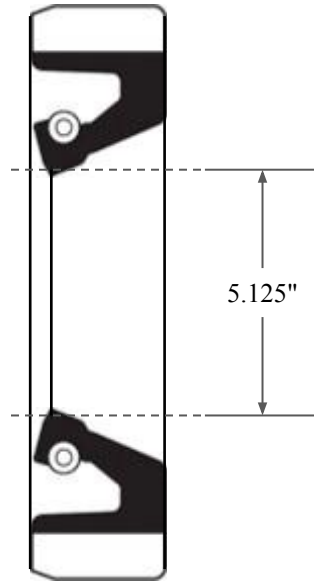

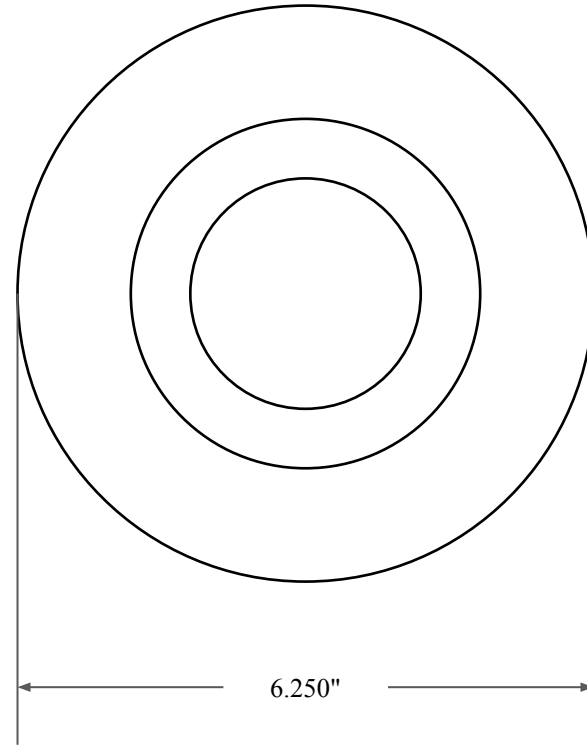

0.625"



5.125"



6.250"

 <b>GLOBAL O-RING</b> and SEAL ALL-AROUND BETTER	PART NUMBER <b>FRS12450B</b>
14450 John F. Kennedy Blvd. Houston, TX 77032	Fabric Reinforced Oil Seal - Nitrile 90 Style B Ref: JM Clipper 0512 4484
Information in this drawing is provided for reference only	