

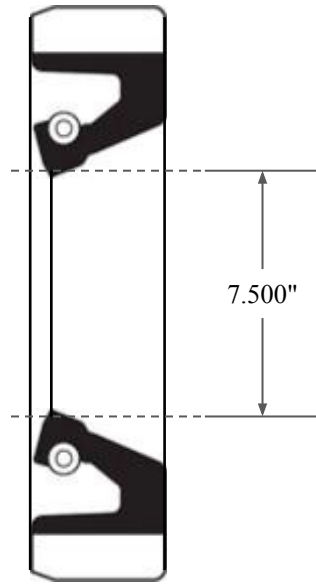

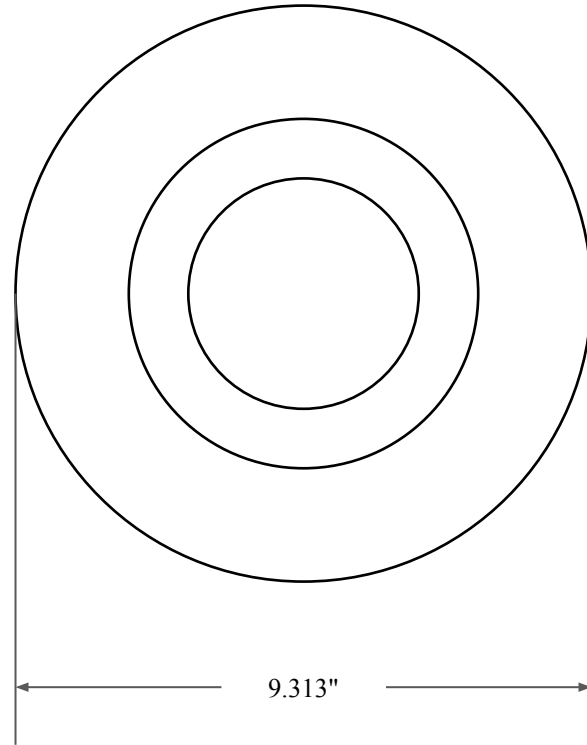

1.059"



7.500"



9.313"

 GLOBAL O-RING and SEAL ALL-AROUND BETTER	PART NUMBER FRS13269B
14450 John F. Kennedy Blvd. Houston, TX 77032 www.globaloring.com	Fabric Reinforced Oil Seal - Nitrile 90 Style B Ref: JM Clipper 18554 H1L5
Information in this drawing is provided for reference only	