

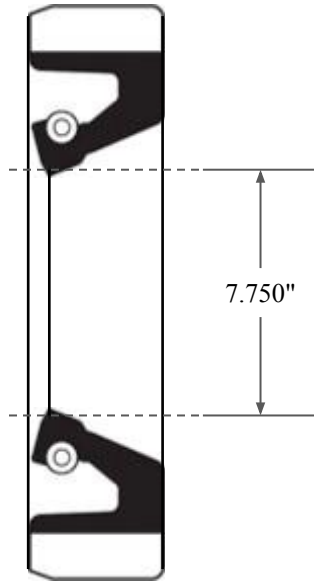

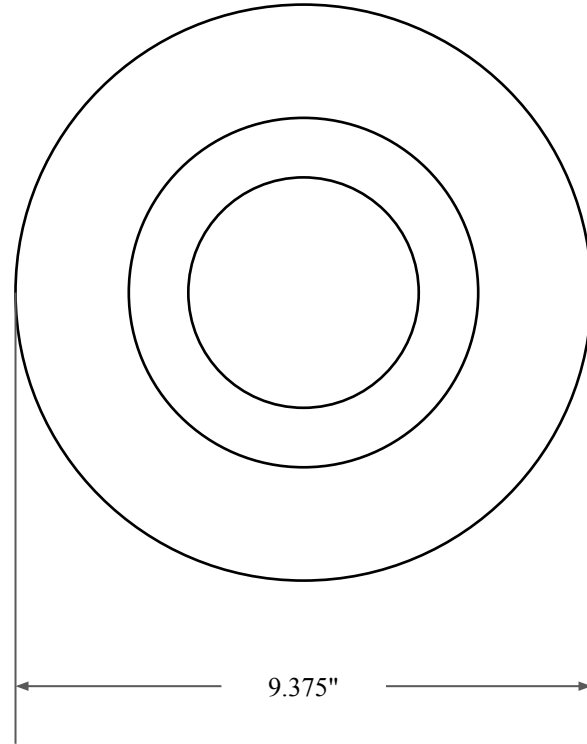

0.625"



7.750"



9.375"

 GLOBAL O-RING and SEAL ALL-AROUND BETTER	PART NUMBER FRS13308B
14450 John F. Kennedy Blvd. Houston, TX 77032 www.globaloring.com	Fabric Reinforced Oil Seal - Nitrile 90 Style B Ref: JM Clipper 15460 H1L5
Information in this drawing is provided for reference only	