

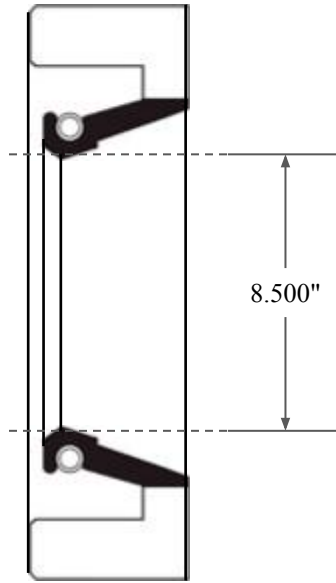

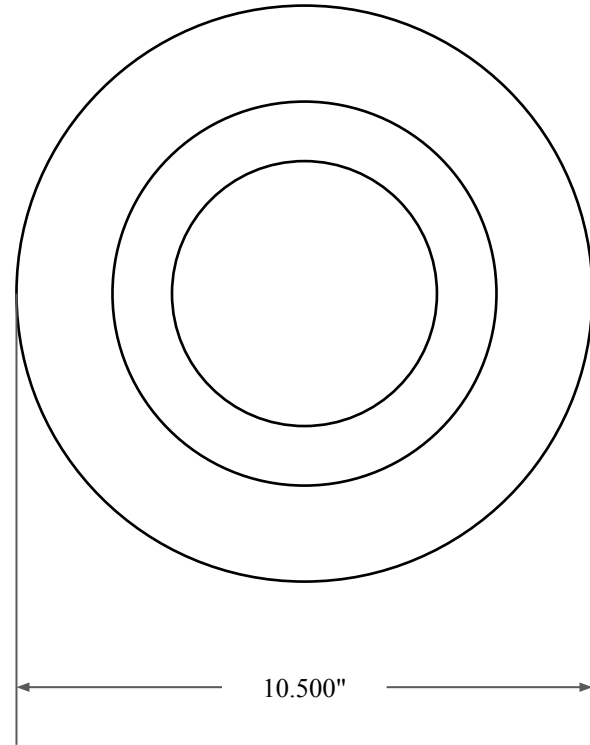

1.000"



8.500"



10.500"

 GLOBAL O-RING and SEAL ALL-AROUND BETTER	PART NUMBER FRS13483A
14450 John F. Kennedy Blvd. Houston, TX 77032	Fabric Reinforced Oil Seal - Nitrile 90 Style A Ref: JM Clipper 8835 HIL5
Information in this drawing is provided for reference only	