

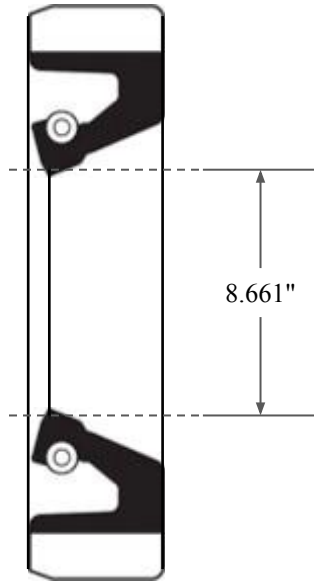

0.591"

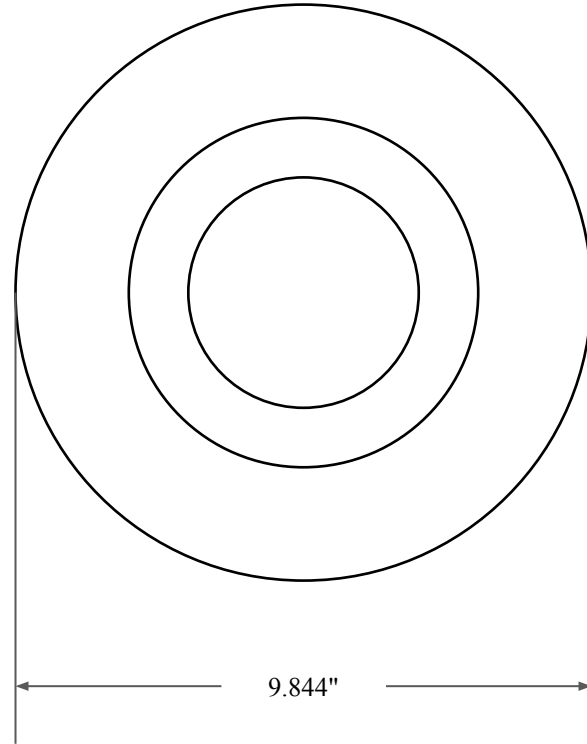

8.661"



9.844"



GLOBAL O-RING
and SEAL
ALL-AROUND BETTER

14450 John F. Kennedy Blvd.
Houston, TX 77032

www.globaloring.com

PART
NUMBER

FRS13514B

Fabric Reinforced Oil Seal - Nitrile 90 Style B
Ref: JM Clipper 18676 H1L5

Information in this drawing is provided for reference only