

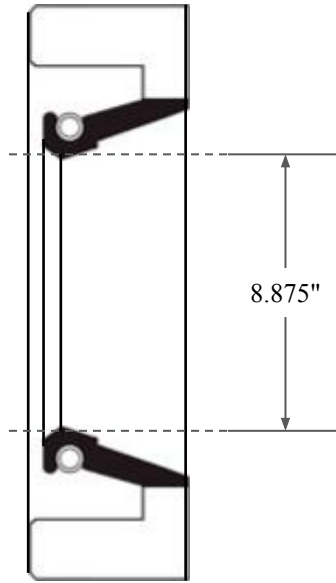

0.750"

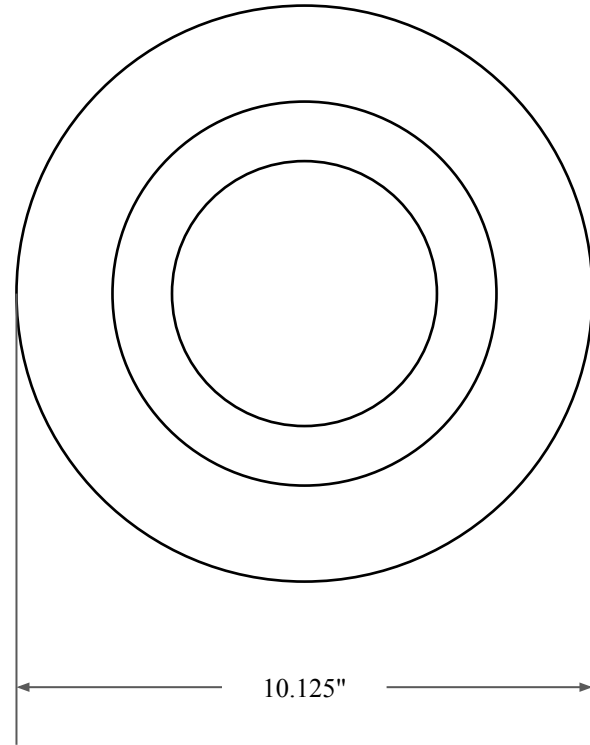

8.875"



10.125"



14450 John F. Kennedy Blvd.
Houston, TX 77032

www.globaloring.com

PART
NUMBER

FRS13555A

Fabric Reinforced Oil Seal - Nitrile 90 Style A
Ref: JM Clipper 9292 H1L5

Information in this drawing is provided for reference only