

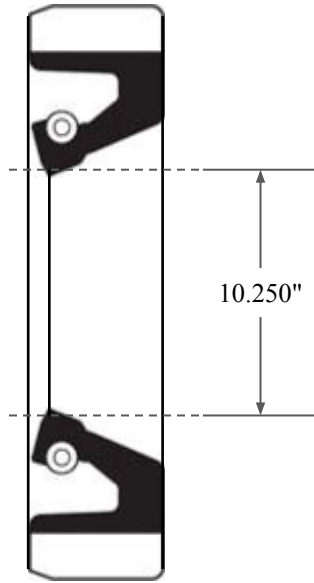

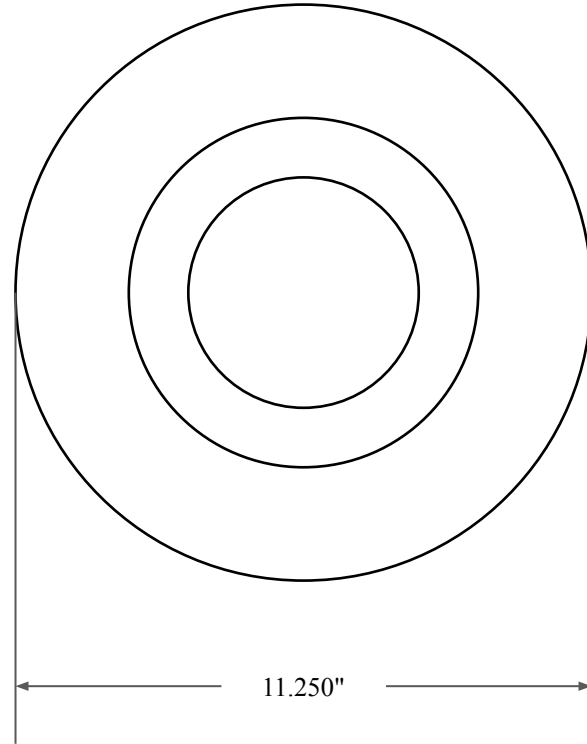

0.750"



10.250"



11.250"

 GLOBAL O-RING and SEAL ALL-AROUND BETTER	PART NUMBER FRS13829B
14450 John F. Kennedy Blvd. Houston, TX 77032	Fabric Reinforced Oil Seal - Nitrile 90 Style B Ref: JM Clipper 6512 H1L5
Information in this drawing is provided for reference only	