

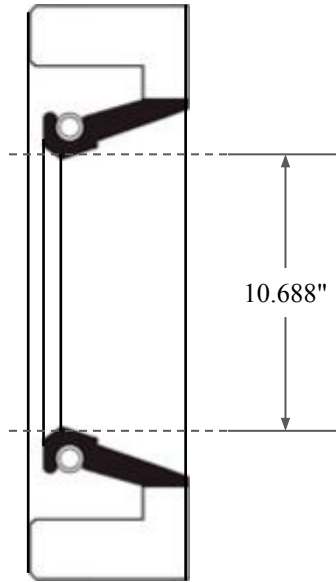

0.750"

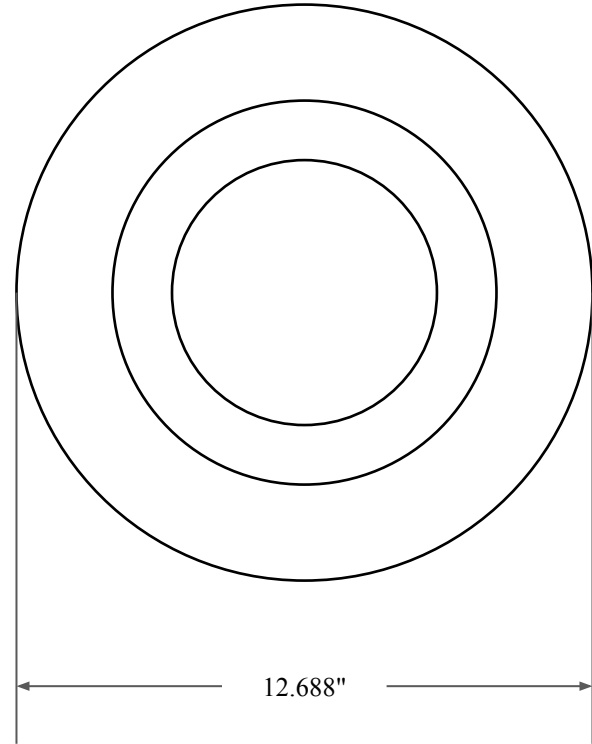

10.688"



12.688"



GLOBAL O-RING
and SEAL
ALL-AROUND BETTER

PART
NUMBER

FRS13899A

14450 John F. Kennedy Blvd.
Houston, TX 77032

www.globaloring.com

Fabric Reinforced Oil Seal - Nitrile 90 Style A
Ref: JM Clipper 15055 H1L5

Information in this drawing is provided for reference only