

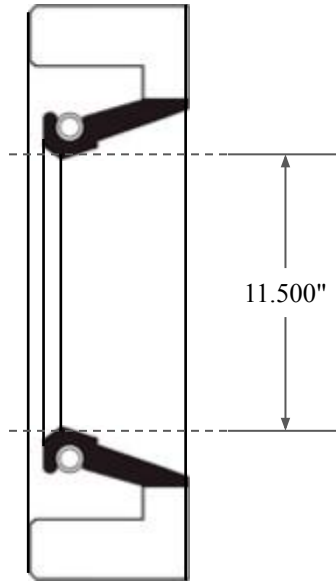

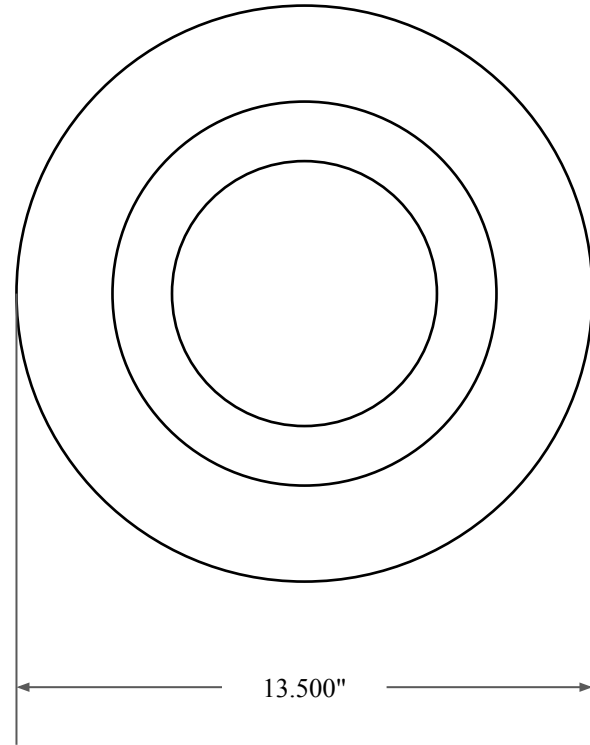

1.000"



11.500"



13.500"

 <p>GLOBAL O-RING and SEAL ALL-AROUND BETTER</p>	PART NUMBER FRS14021AV90
14450 John F. Kennedy Blvd. Houston, TX 77032	Fabric Reinforced Oil Seal - Viton 90 Style A Ref: JM Clipper 10509 HSL16
Information in this drawing is provided for reference only	