

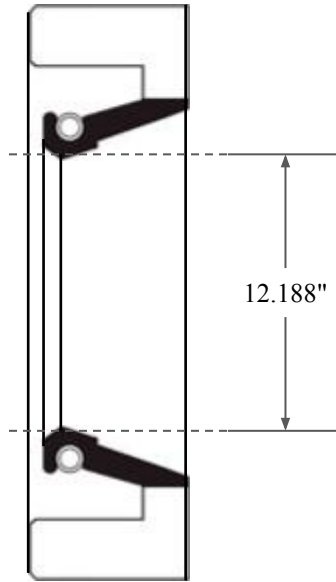

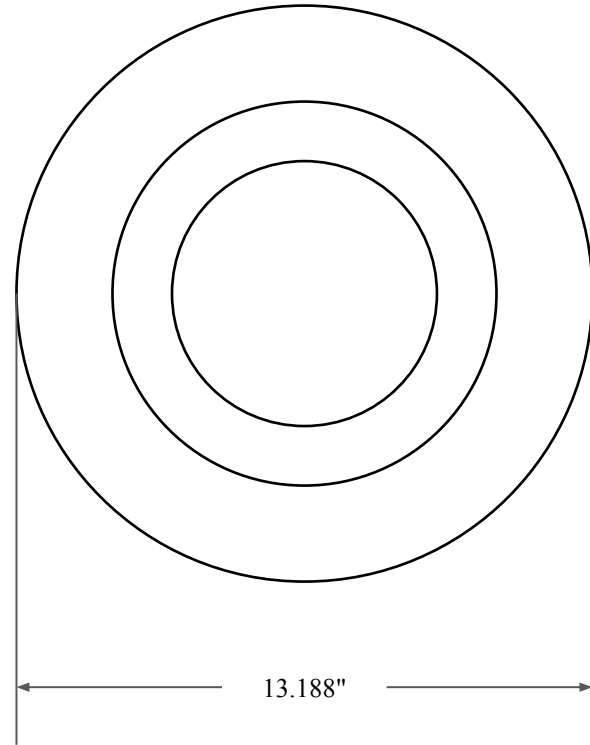

0.563"



12.188"



13.188"

 GLOBAL O-RING and SEAL ALL-AROUND BETTER	PART NUMBER FRS14097A
14450 John F. Kennedy Blvd. Houston, TX 77032 www.globaloring.com	Fabric Reinforced Oil Seal - Nitrile 90 Style A Ref: JM Clipper 16026 H1L5
Information in this drawing is provided for reference only	