

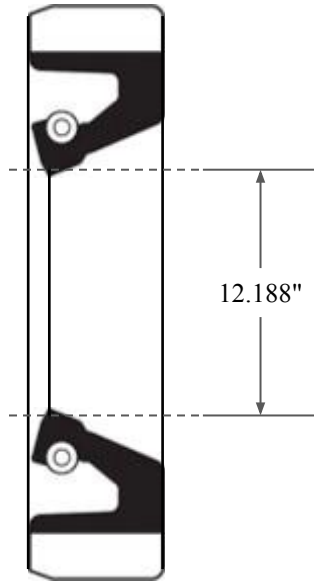

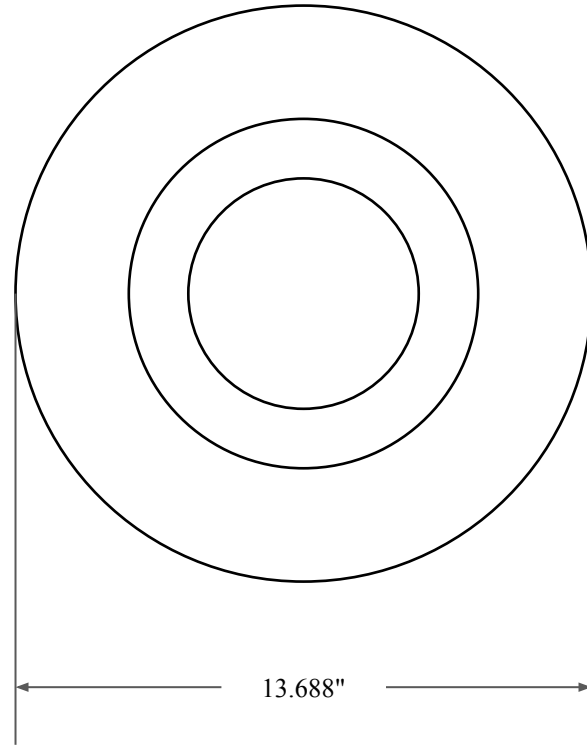

0.625"



12.188"



13.688"

 GLOBAL O-RING and SEAL ALL-AROUND BETTER	PART NUMBER FRS14098BV90
14450 John F. Kennedy Blvd. Houston, TX 77032 www.globaloring.com	Fabric Reinforced Oil Seal - Viton 90 Style B Ref: JM Clipper 9424 H5L16
Information in this drawing is provided for reference only	