

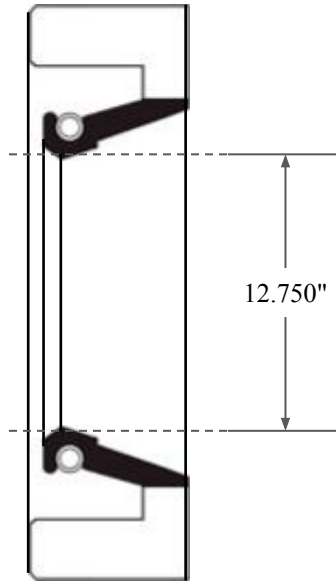

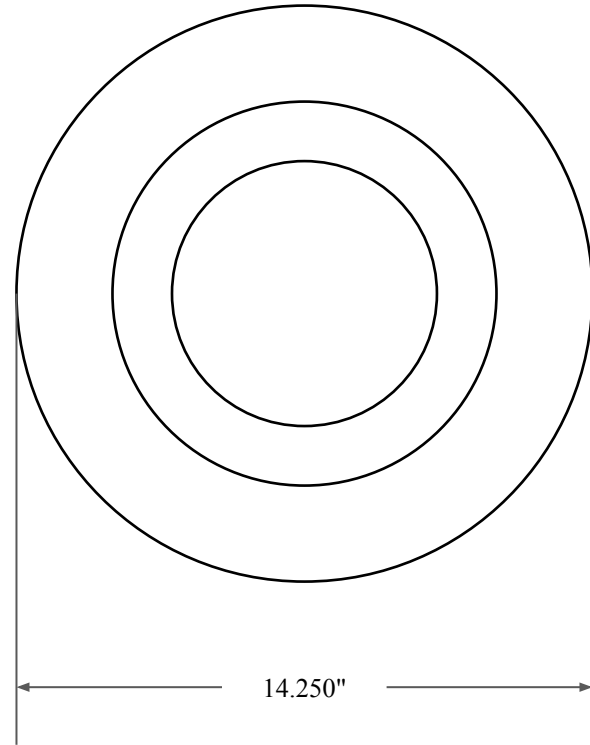

0.750"



12.750"



14.250"

 GLOBAL O-RING and SEAL ALL-AROUND BETTER	PART NUMBER FRS14184AV90
14450 John F. Kennedy Blvd. Houston, TX 77032 www.globaloring.com	Fabric Reinforced Oil Seal - Viton 90 Style A Ref: JM Clipper 5641 H5MX5489
Information in this drawing is provided for reference only	