

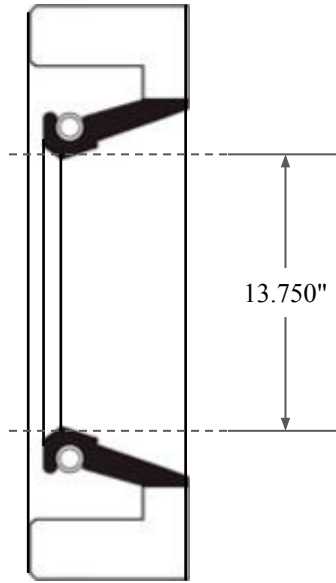

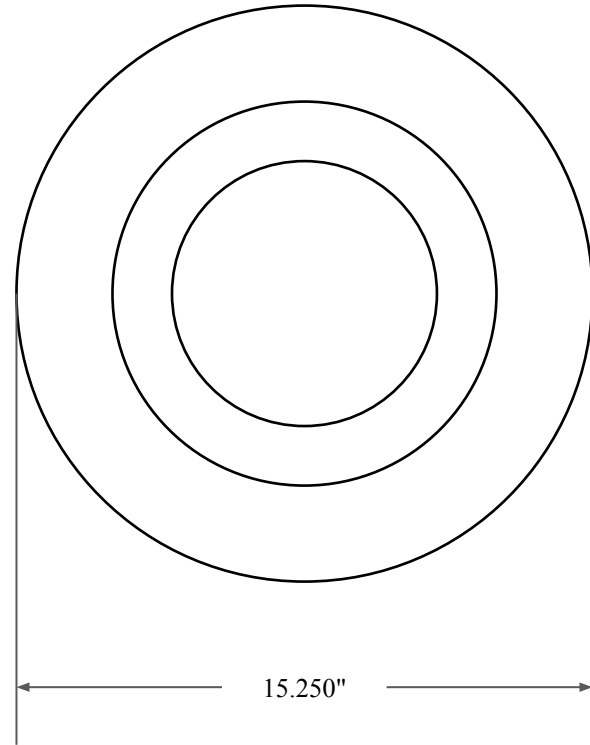

0.750"



13.750"



15.250"

 GLOBAL O-RING and SEAL ALL-AROUND BETTER	PART NUMBER FRS14285AV90
14450 John F. Kennedy Blvd. Houston, TX 77032 www.globaloring.com	Fabric Reinforced Oil Seal - Viton 90 Style A Ref: JM Clipper 11748 H5L89
Information in this drawing is provided for reference only	